

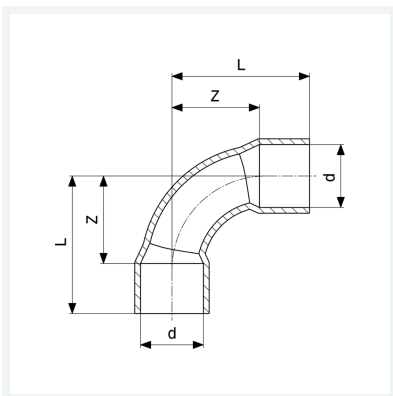

**Bogen 90°**  
- Lötanschluss  
**Modell 95002A**

**Artikel 100 063**



## Eigenschaften

Gütesicherung Cu	Cu	✓
Rohraußendurchmesser	d	22
Z-Maß	Z	26 mm
Länge	L	42 mm
Gewicht	46,9 g	
Volumen	69,3 cm <sup>3</sup>	
Werkstoff	Kupfer	