



## Kupplung mit SC-Contur

- für Fonterra-Flächentemperierung, Verbindung von Fonterra-Rohren
- Pressanschlüsse

**Modell 1223**

**Artikel 614 683**

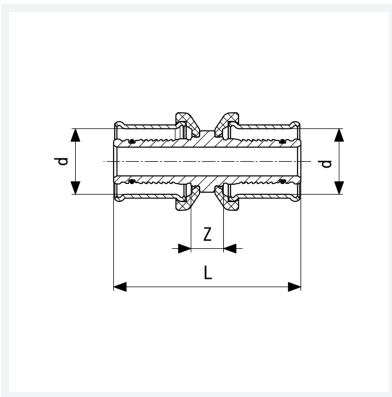

## Eigenschaften

Rohraußendurchmesser	d	15
Z-Maß	Z	11 mm
Länge	L	45 mm
Gewicht	43,26 g	
Volumen	41,44 cm <sup>3</sup>	
Werkstoff	Rotguss	