

**Sanpress Inox G-Bogen 45°
mit SC-Contur**

- Pressanschlüsse

Ausstattung

Dichtelemente HNBR

Modell 0226

Artikel 486 150

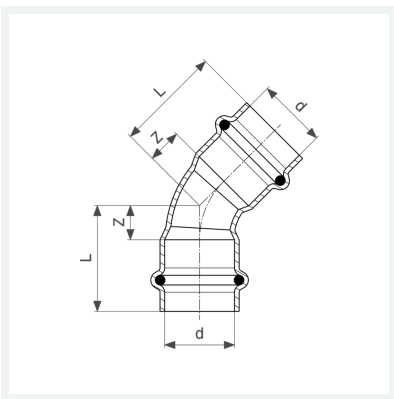

Eigenschaften

Rohraußendurchmesser	d	28
Z-Maß	Z	14 mm
Länge	L	38 mm
Gewicht	90 g	
Volumen	248,64 cm ³	
Werkstoff	Stahl nichtrostend	