

X-Line

3314218000 Waschtischunterbau

PRODUKT

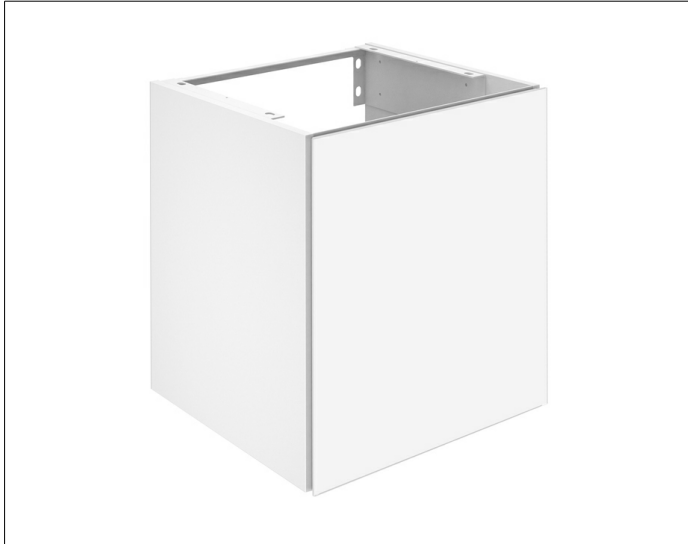

ZEICHNUNG

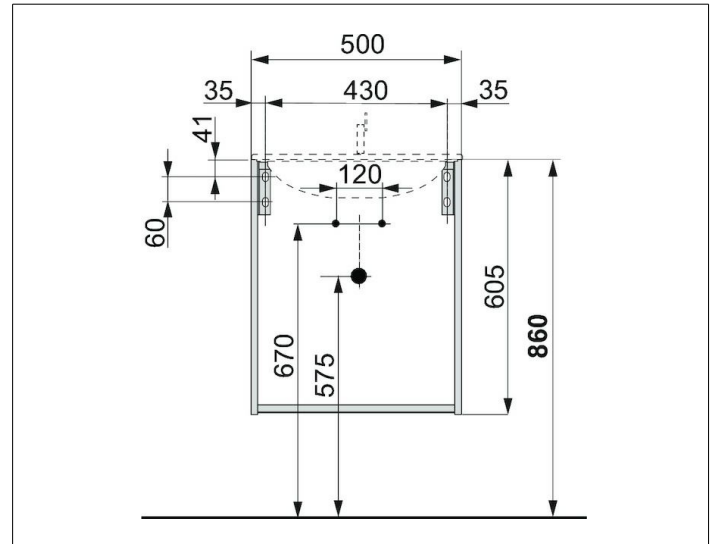

OBERFLÄCHE

cashmere/cashmere

ABMESSUNG

500 x 605 x 490 mm