

X-Line

33181180000 Waschtischunterbau

PRODUKT

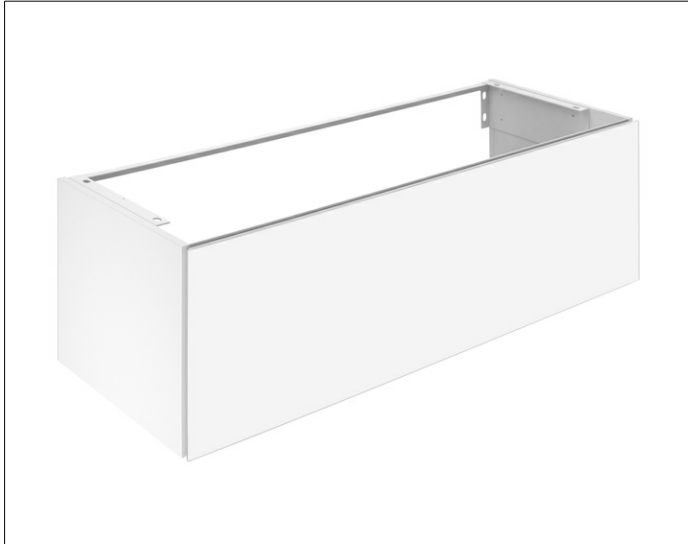

ZEICHNUNG

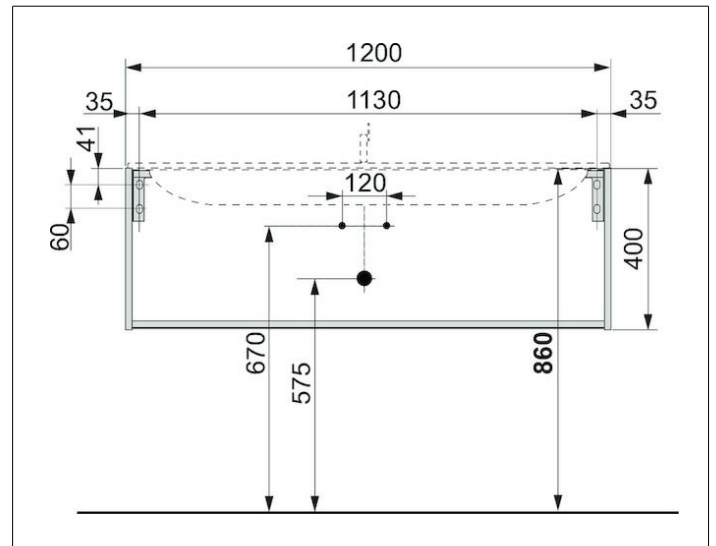

OBERFLÄCHE

cashmere/cashmere

ABMESSUNG

1200 x 400 x 490 mm