



Temponox XL-Bogen 45° mit SC-Contur

- Pressanschlüsse

Ausstattung

Dichtelemente EPDM, Schneidringe, Trennringe

Modell 1726XL

Artikel 809 928

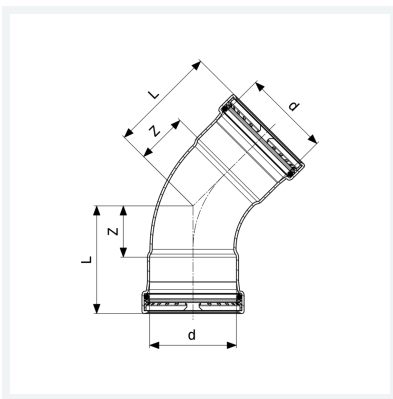

Eigenschaften

Rohraußendurchmesser	d	76,1
Z-Maß	Z	46 mm
Länge	L	96 mm
Gewicht	850 g	
Volumen	3108 cm ³	
Werkstoff	Stahl nichtrostend	