

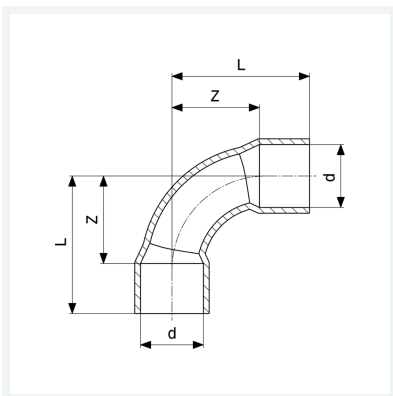

Bogen 90°
- Lötanschluss
Modell 95002A

Artikel 100 148



Eigenschaften

Gütesicherung Cu	Cu	✓
Rohraußendurchmesser	d	18
Z-Maß	Z	21 mm
Länge	L	34 mm
Gewicht	27,7 g	
Volumen	49,7 cm ³	
Werkstoff	Kupfer	