

STEINBERG



Waschtisch-Einhebelmischbatterie

Art.Nr.250 1550

Installation

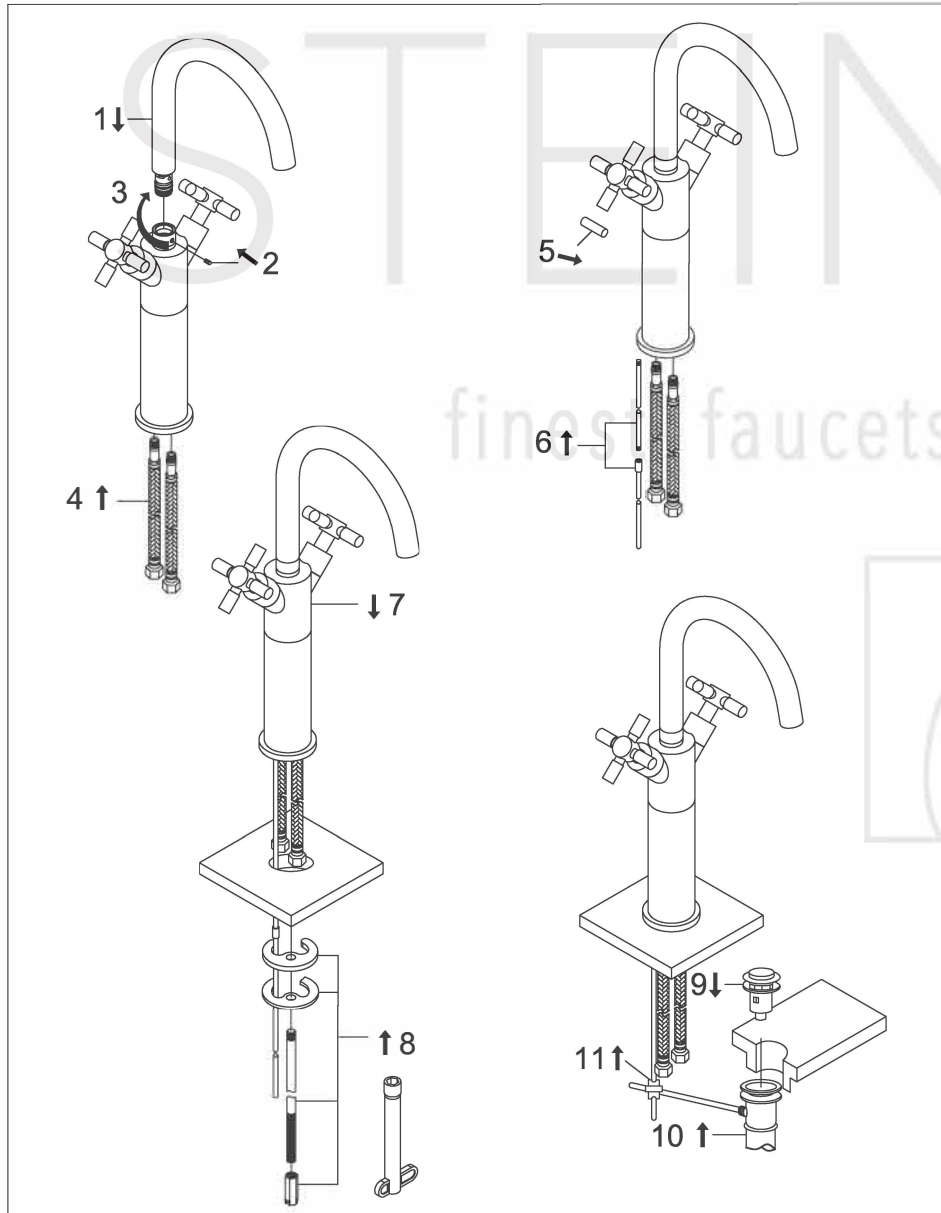

Technische Zeichnung

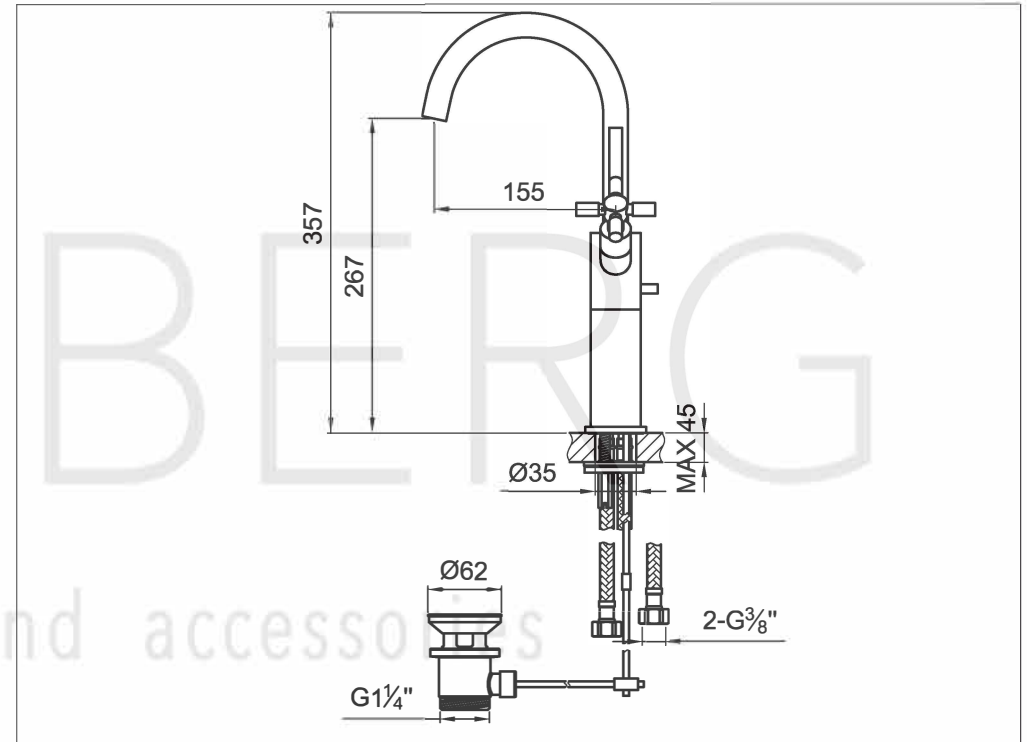

Explosionszeichnung

