



Kupplung

- für Fonterra-Flächentemperierung, Verbindung von Fonterra-Rohren
- Klemmanschluss

Modell 1030.5

Artikel 615 789

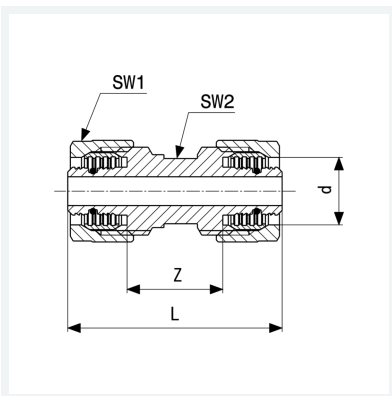

Eigenschaften

Rohraußendurchmesser	d	15
Z-Maß	Z	24 mm
Länge	L	54 mm
Schlüsselweite 1	SW1	24 mm
Schlüsselweite 2	SW2	17 mm
Gewicht	140 g	
Volumen	62,16 cm ³	
Werkstoff	Messing	