

DE Montageanleitung

EN Mounting instruction

ES Instrucciones de instalación

FR Instructions d'installation

IT Istruzioni per l'installazione

NL Montagehandleiding

CS Návod k instalaci

PL Instrukcja montażu

RU Инструкция по монтажу

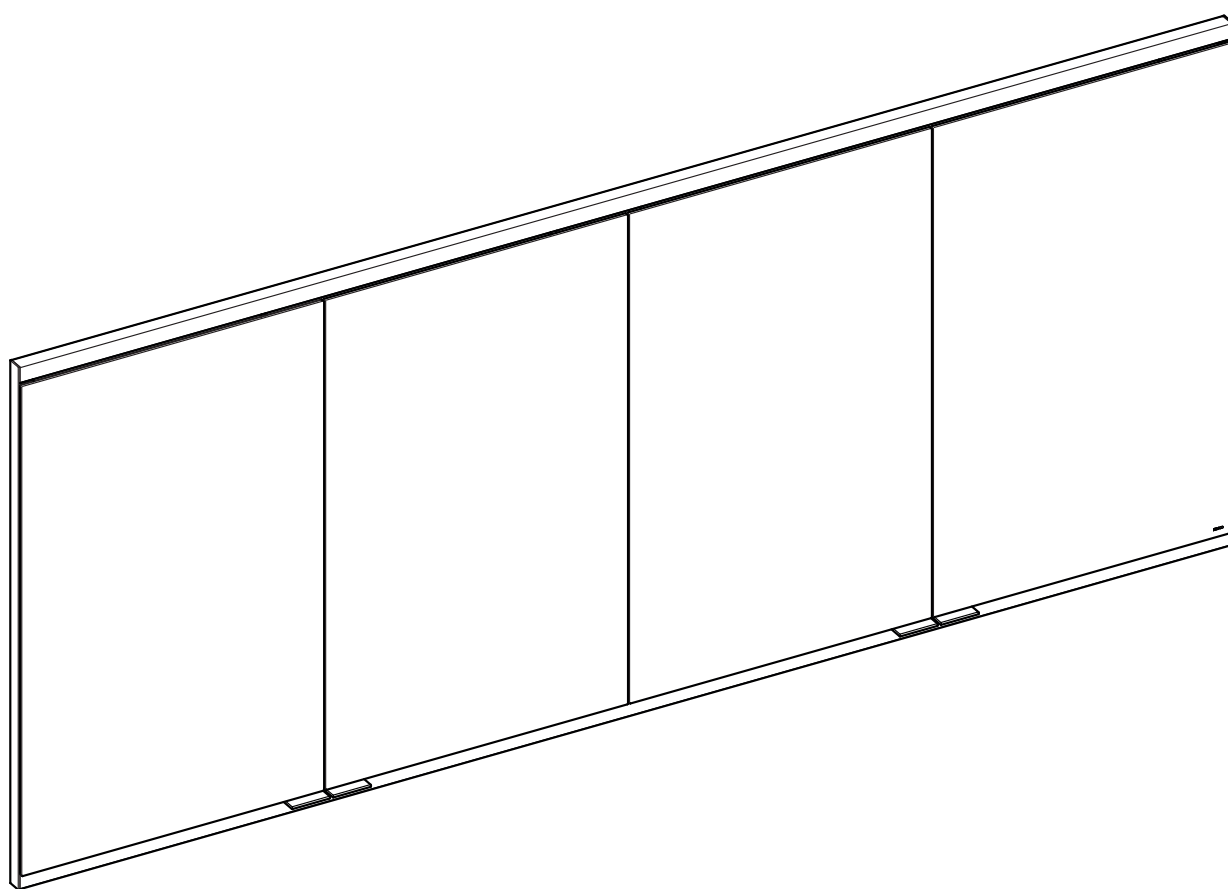

800400DDEG0X000

DE Einbaumaße

FR Cotes de montage

CS Montážní rozměry

EN Mounting dimensions

IT Ingombro

PL Wymiary montażowe

ES Dimensiones de montaje

NL Montageafmetingen

RU Монтажные размеры

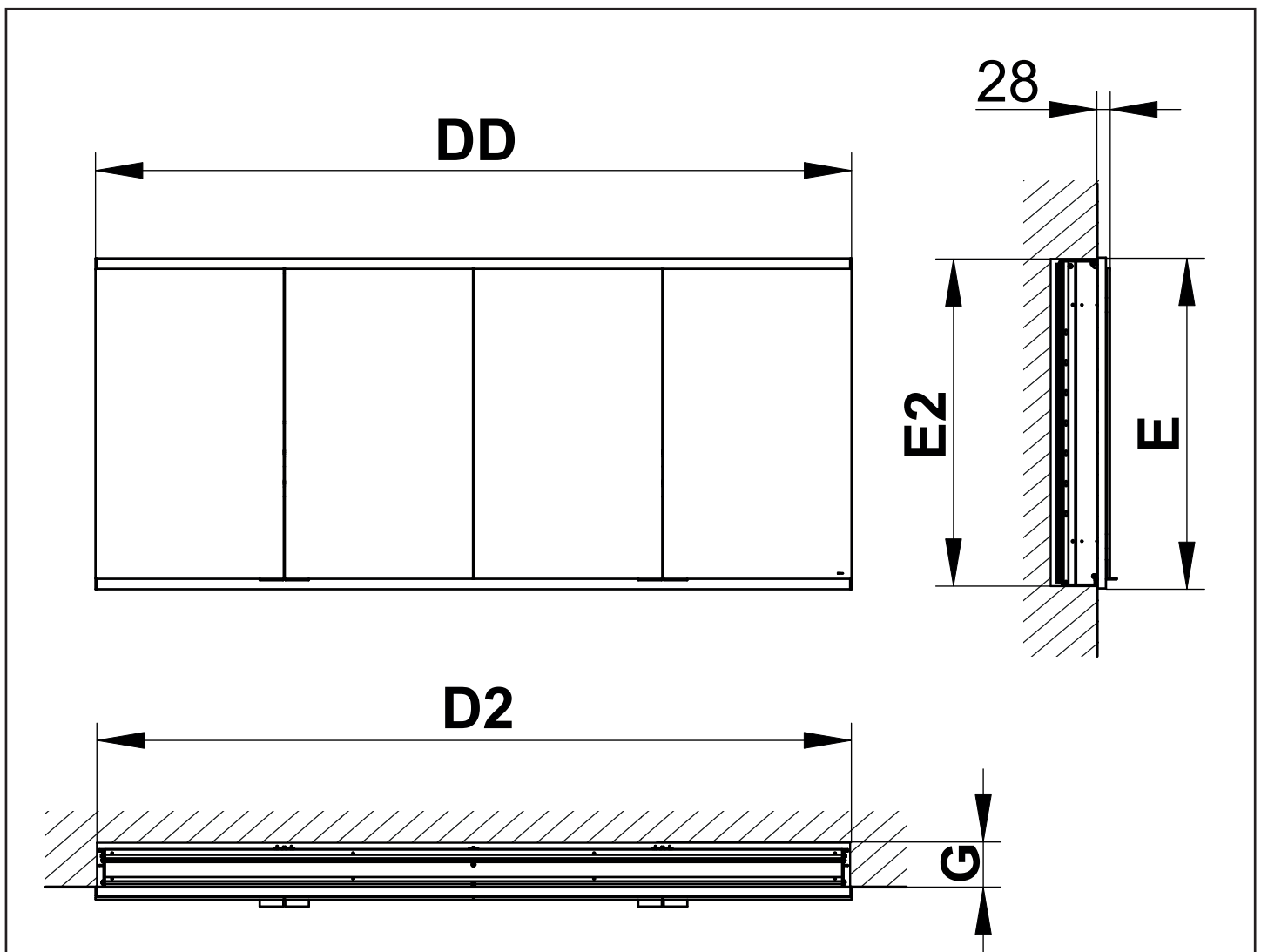



	DD	D2	E	E2	G
800400160G0X000	1600	1586 - 1594	700	686 - 690	>102 / >142
800400170G0X000	1700	1686 - 1694	700	686 - 690	>102 / >142
800400010G0X000	1750	1736 - 1744	700	686 - 690	>102 / >142
800400180G0X000	1800	1786 - 1794	700	686 - 690	>102 / >142
800400190G0X000	1900	1886 - 1894	700	686 - 690	>102 / >142
800400200G0X000	2000	1986 - 1994	700	686 - 690	>102 / >142
800400210G0X000	2100	2086 - 2094	700	686 - 690	>102 / >142
800400161G0X000	1600	1586 - 1594	900	886 - 890	>102 / >142
800400171G0X000	1700	1686 - 1694	900	886 - 890	>102 / >142
800400011G0X000	1750	1736 - 1744	900	886 - 890	>102 / >142
800400181G0X000	1800	1786 - 1794	900	886 - 890	>102 / >142
800400191G1X000	1900	1886 - 1894	900	886 - 890	>102 / >142
800400201G1X000	2000	1986 - 1994	900	886 - 890	>102 / >142
800400211G1X000	2100	2086 - 2094	900	886 - 890	>102 / >142

DE Wichtige Informationen, bitte unbedingt lesen!

 Diese Anleitung ist für den Installateur zur Montage sowie für den Nutzer zur Bedienung und Wartung des Produktes. Bitte nach der Installation an den Nutzer zur Verwahrung weitergeben.

Symbole und Bedeutung

 **Achtung!** Warnung vor Personen- oder Sachschaden.

 **Achtung!** Warnung vor Stromschlag.

 **Achtung!** Warnung vor Wasserschaden.

 Hinweis, Tipp oder Verweis

 Korrekte Montage/Funktionsprüfung

 Falsche Montage

 Montagedetail beachten

 Optional/Zubehör

Sicherheitsinformationen

 Es muss sichergestellt sein, dass die Wand das Gewicht des Spiegels tragen kann.

 Zur Vermeidung von Personen- und Sachschäden muss die Montage von zwei Personen durchgeführt werden.

Verwendungszweck

 Produkt ausschließlich zur Montage in Innenräumen geeignet!

 **Achtung!** Installation nur in frostfreien Räumen.

Einbaumaße, siehe Seite 2.

Installation, siehe ab Bild 1 auf Seite 8.

Ersatzteile mit Bestellnummern, siehe Seite 15.

 Hinweise zur Gewährleistung und Pflege sind dem beiliegendem **Pflege- und Garantiepass** zu entnehmen.

EN Important information, please read!

 These instructions are designed for the installation engineer to assemble the product and for the user to operate and maintain it. After installation, please pass them on to the user for safekeeping.

Symbols and their meaning

 **Caution!** Warning of personal injury or material damage

 **Caution!** Warning of electric shock.

 **Caution!** Warning of water damage.

 Note, tip or reference

 Correct assembly/functional test

 Incorrect assembly

 Observe assembly details

 Optional/accessories

Safety Information

 It must be ensured that the wall can support the weight of the mirror.

 To prevent personal injury or material damage the assembly must be carried out by two persons.

Intended use

 The product is suitable only for mounting indoors!

 **Caution!** Only install in frost-free rooms.

Mounting dimensions, see page 2.









Installation, see figure 1 onwards on page 8.

Replacement parts with order numbers, see page 15.

 For information about warranty and maintenance, see the enclosed **Care Instructions and Warranty Card**.

 Este manual está destinado al instalador para el montaje, así al usuario para el manejo y mantenimiento del producto. Por favor, después de la instalación este manual se debe entregar al usuario para que lo conserve.

Símbolos y significado



-  **¡Atención!** Advertencia de daños personales o materiales.
-  **¡Atención!** Advertencia de descarga eléctrica.
-  **¡Atención!** Advertencia de daños a causa del agua.
-  Indicación, consejo o referencia
-  Montaje correcto/Comprobación de funcionamiento
-  Montaje erróneo
-  Observar el detalle de montaje
-  Opcional/Accesorios

Informaciones de seguridad

 Tiene que estar asegurado, que la pared puede soportar el peso del espejo.

 Para evitar daños personales y materiales el montaje tiene que ser llevado a cabo con dos personas.

Finalidad de uso

-  ¡Producto exclusivamente para el montaje en interiores!
-  **¡Atención!** Instalación exclusivamente en espacios sin hielo.

Medidas de montaje, véase página 2.









Instalación, véase imagen 1 en la página 8.

Piezas de recambio con números de pedido, véase página 15.

 La información sobre la garantía y el cuidado se puede encontrar en el **manual de mantenimiento y de garantía** adjunto.

 Ces instructions sont destinées à l'installateur, pour effectuer le montage, et à l'utilisateur, pour utiliser le produit et procéder à sa maintenance. Après l'installation, veuillez remettre ces instructions à l'utilisateur pour qu'il les conserve.

Symboles et leur signification



-  **Attention !** Mise en garde contre les dégâts de personnes et les dégâts matériels.
-  **Attention !** Mise en garde contre les chocs électriques.
-  **Attention !** Mise en garde contre les endommagements par l'eau.
-  Remarque, conseil ou renvoi
-  Montage correct/contrôle fonctionnel
-  Montage incorrect
-  Respecter le détail de montage
-  Option/accessoires

Informations en matière de sécurité

 Il convient de s'assurer que le mur peut supporter le poids du miroir.

 Pour éviter les dégâts de personnes et les dégâts matériels, le montage doit être effectué par deux personnes.

Domaine d'utilisation

-  Le produit ne convient que pour un montage à l'intérieur !
-  **Attention !** Installation uniquement dans des pièces à l'abri du gel.

Côtes d'encombrement, voir page 2.

Installation, voir à partir de la figure 1, à la page 8.

Pièces de rechange avec numéros de commande, voir page 15.

 Les consignes relatives à la garantie et à l'entretien figurent sur la **instructions d'entretien et carte de garantie** jointe.

 Il presente manuale è indirizzato agli installatori per il montaggio nonché agli utilizzatori per l'uso e la manutenzione del prodotto. Consegnarlo all'utilizzatore dopo l'installazione affinché lo custodisca.

Simboli e significato

 **Attenzione!** Pericolo di lesioni o danni materiali.

 **Attenzione!** Pericolo di folgorazione.

 **Attenzione!** Pericolo di danni causati dall'acqua.

 Avvertenza, consiglio o rimando

 Montaggio corretto/verifica del funzionamento

 Montaggio errato

 Prestare attenzione al dettaglio di montaggio

 Opzionale/accessorio

Informazioni di sicurezza

 Deve essere garantito che la parete possa supportare il peso dello specchio.

 Al fine di evitare lesioni e danni materiali il montaggio deve essere eseguito da due persone.

Scopo d'uso

 Prodotto adatto esclusivamente per il montaggio in ambienti interni!

 **Attenzione!** Installazione solo in ambienti in assenza di gelo.

Dimensioni di montaggio, vedi pagine 2.

Installazione, vedi dalla figura 1 a pagina 8.

Ricambi con numero d'ordine, vedi pagina 15.

 Indicazioni relative alla garanzia e al trattamento vanno desunte dalle **istruzioni di manutenzione e certificato di garanzia**.

 Deze handleiding is zowel voor de installatiemonteur, als voor de gebruiker voor de bediening en het onderhoud van het product bedoeld. Geef de handleiding na de installatie aan de gebruiker om te bewaren.

Symbolen en betekenis

 **Opgepast!** Waarschuwing voor lichamelijke en materiële schade.

 **Opgepast!** Waarschuwing voor elektrische schokken.

 **Opgepast!** Waarschuwing voor waterschade.

 Aanwijzing, tip of verwijzing

 Controle van correcte montage/werking

 Verkeerde montage

 Montagedetail respecteren

 Optioneel/accessoire

Veiligheidsinformatie

 Er moet worden gecontroleerd of de wand het gewicht van de spiegel kan dragen.

 Om schade aan personen of zaken te vermijden moet de montage door twee personen worden uitgevoerd.

Beoogd gebruik

 Het product is uitsluitend voor montage in binnenruimten geschikt!

 **Opgepast!** Installatie alleen in vorstvrije ruimten.

Inbouwafmetingen, zie pagina 2.









Installatie, zie vanaf afbeelding 1 op pagina 8.

Wisselstukken met bestelnummers, zie pagina 15.



 Instructies voor de waarborg en het onderhoud vindt u in de meegeleverde **aanwijzingen voor het onderhoud en garantiebewijs**.

 Tento návod slouží instalatérům při montáži a uživatelům při obsluze a údržbě produktu. Po nainstalování ho předejte uživateli, aby si ho mohl uschovat.



Symbole a jejich význam

-  **Pozor!** Výstraha před zraněním a materiálními škodami.
-  **Pozor!** Výstraha před úrazem elektrickým proudem.
-  **Pozor!** Výstraha před poškozením vodou.
-  Upozornění, tip nebo odkaz
-  Správná montáž / kontrola funkčnosti
-  Nesprávná montáž
-  Při montáži dbejte na tento detail
-  Volitelná výbava / příslušenství

Informace o bezpečnosti

-  Je nutné zajistit, aby stěna unesla hmotnost zrcadlové skříňě.
-  Aby se zabránilo zraněním a materiálním škodám, musí montáž provádět dvě osoby.

Účel použití

-  Výrobek je vhodný výhradně k montáži ve vnitřních prostorech!
-  **Pozor!** Instalace v prostorech, které nepromrzají.

Montážní rozměry viz straně 2.









Instalace viz obr. 1 na straně 8.

Náhradní díly s objednáacími čísly viz straně 15.



 Pokyny týkající se záruky a péče najdete v příloženém **Návodu k údržbě a záručním listu**.

 Instrukcja przeznaczona jest dla instalatora, zapewniając pomoc w zakresie montażu oraz dla użytkownika, informując go o sposobie obsługi i konserwacji produktu. Po instalacji należy przekazać instrukcję użytkownikowi, aby ją u siebie przechowywał.



Symbole i znaczenie

-  **Uwaga!** Ostrzeżenie przed szkodami osobowymi i materialnymi.
-  **Uwaga!** Ostrzeżenie przed porażeniem prądem elektrycznym.
-  **Uwaga!** Ostrzeżenie przed szkodami, spowodowanymi przez wodę.
-  Informacja, dobra rada lub odsylacz
-  Właściwy montaż/kontrola funkcjonowania
-  Niewłaściwy montaż
-  Należy stosować się do danych, dotyczących montażu
-  Opcje/Osprzęt

Informacje dotyczące bezpieczeństwa

-  Należy upewnić się, że ściana jest w stanie unieść ciężar lustra.
-  W celu uniknięcia szkód osobowych i materialnych montaż powinny wykonywać dwie osoby.

Przeznaczenie

-  Produkt przeznaczony jest wyłącznie do montażu wewnątrz budynków!
-  **Uwaga!** Instalacja wyłącznie w pomieszczeniach, w których temperatura nie spada poniżej zera.

3Wymiary zabudowy, patrz stronie 2.

Instalacja, patrz rys. 1 na stronie 8 i dalsze.

Części zamiennie z numerami zamówienia, patrz stronie 15.

 Informacje dotyczące gwarancji dostępne są w dołączonej **instrukcja konserwacji i karta gwarancyjna**.

1

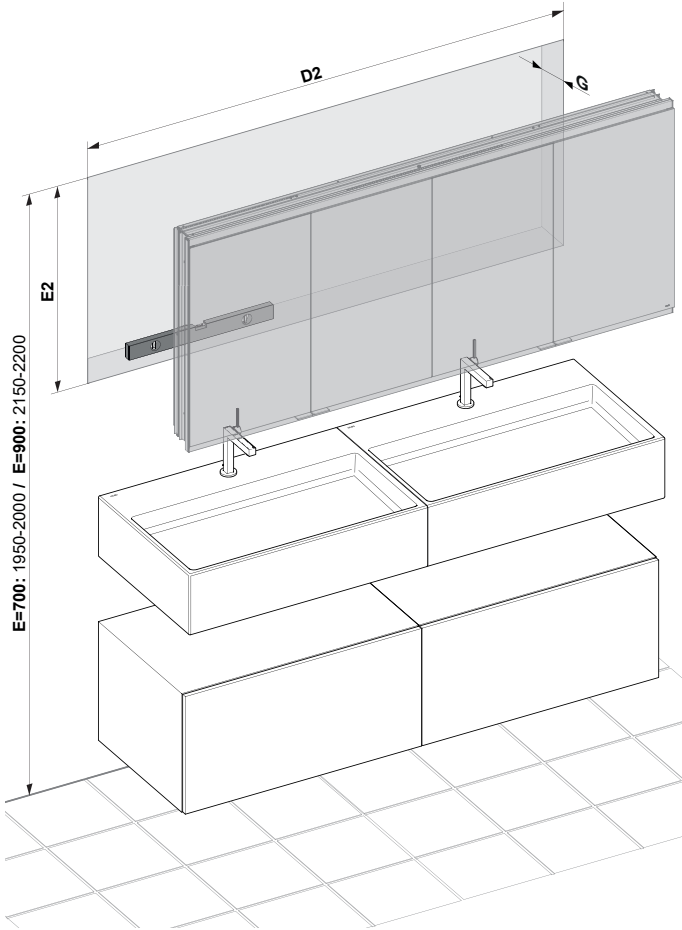
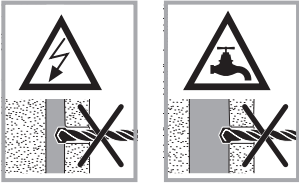

E=700: 1950-2000 / E=900: 2150-2200

	DD	D2	E	E2	G
800400160G0X000	1600	1586-1594	700	686-690	120 / 160
800400170G0X000	1700	1686-1694	700	686-690	120 / 160
800400010G0X000	1750	1736-1744	700	686-690	120 / 160
800400180G0X000	1800	1786-1794	700	686-690	120 / 160
800400190G0X000	1900	1886-1894	700	686-690	120 / 160
800400200G0X000	2000	1986-1994	700	686-690	120 / 160
800400210G0X000	2100	2086-2094	700	686-690	120 / 160
800400161G0X000	1600	1586-1594	900	886-890	120 / 160
800400171G0X000	1700	1686-1694	900	886-890	120 / 160
800400011G0X000	1750	1736-1744	900	886-890	120 / 160
800400181G0X000	1800	1786-1794	900	886-890	120 / 160
800400191G0X000	1900	1886-1894	900	886-890	120 / 160
800400201G0X000	2000	1986-1994	900	886-890	120 / 160
800400211G0X000	2100	2086-2094	900	886-890	120 / 160

2

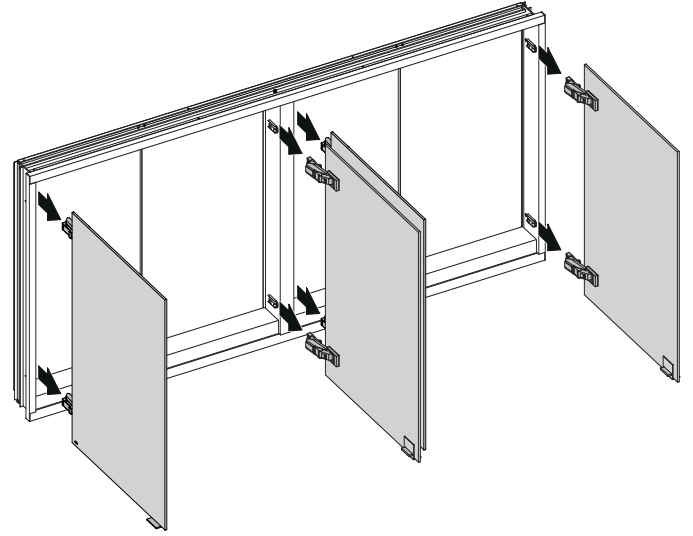

3

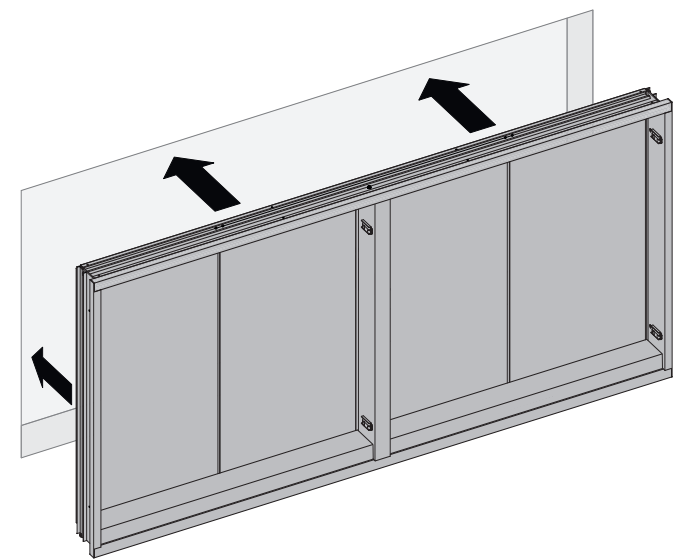

4

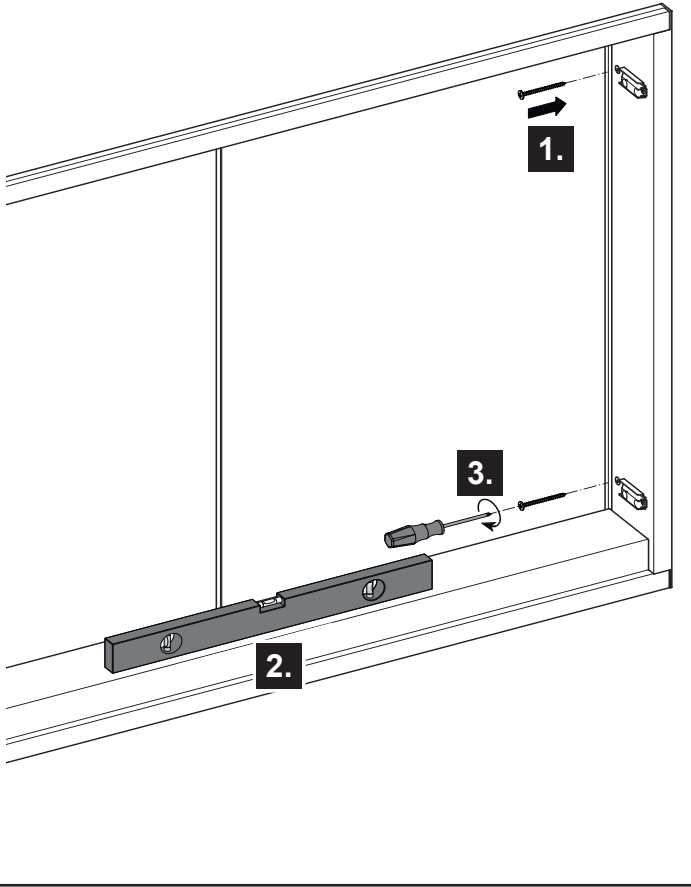

5

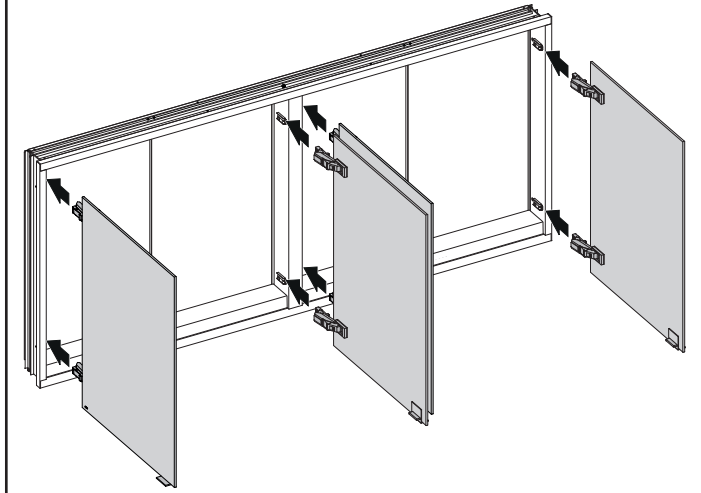

6

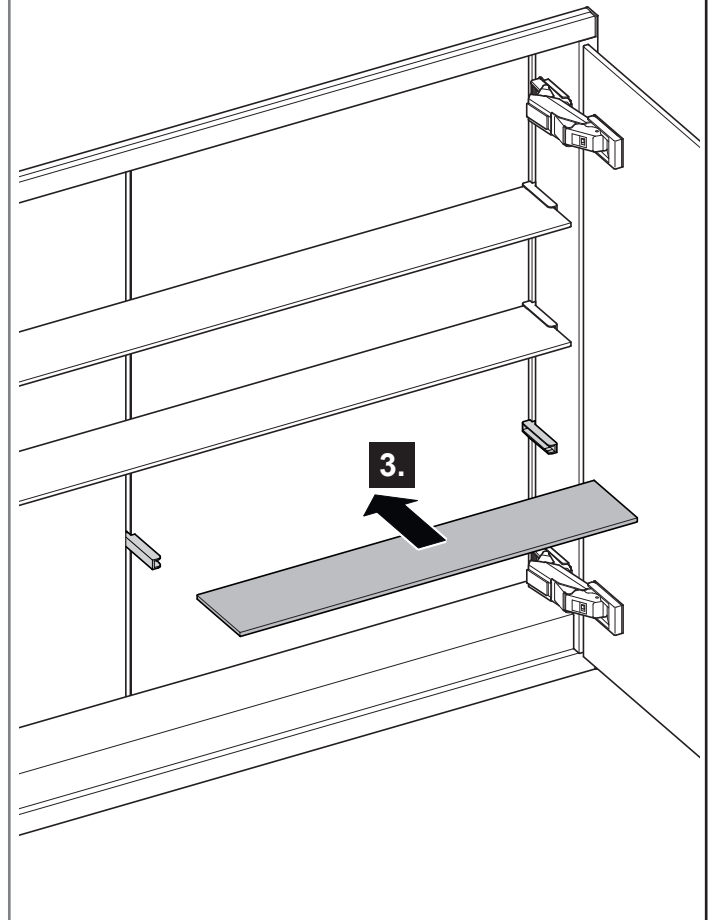
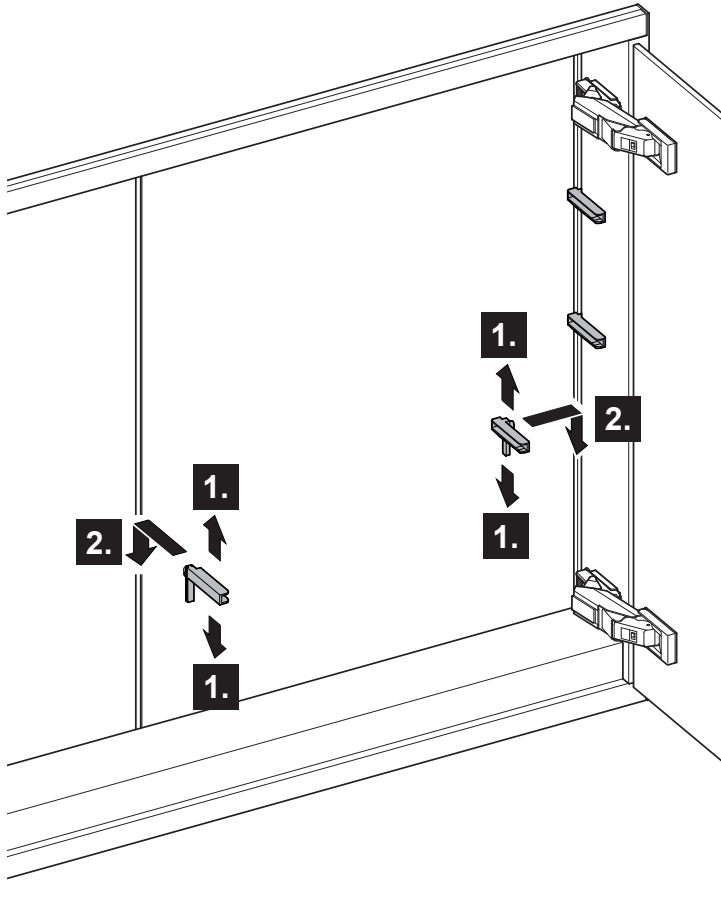

7 

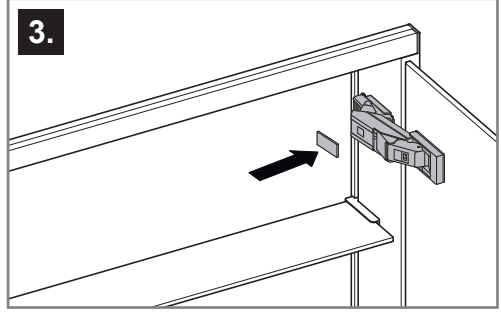
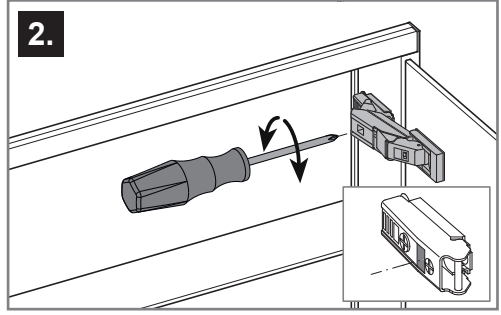
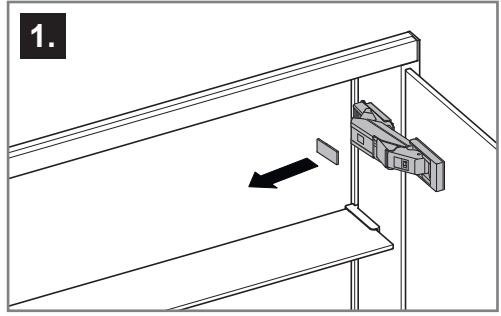
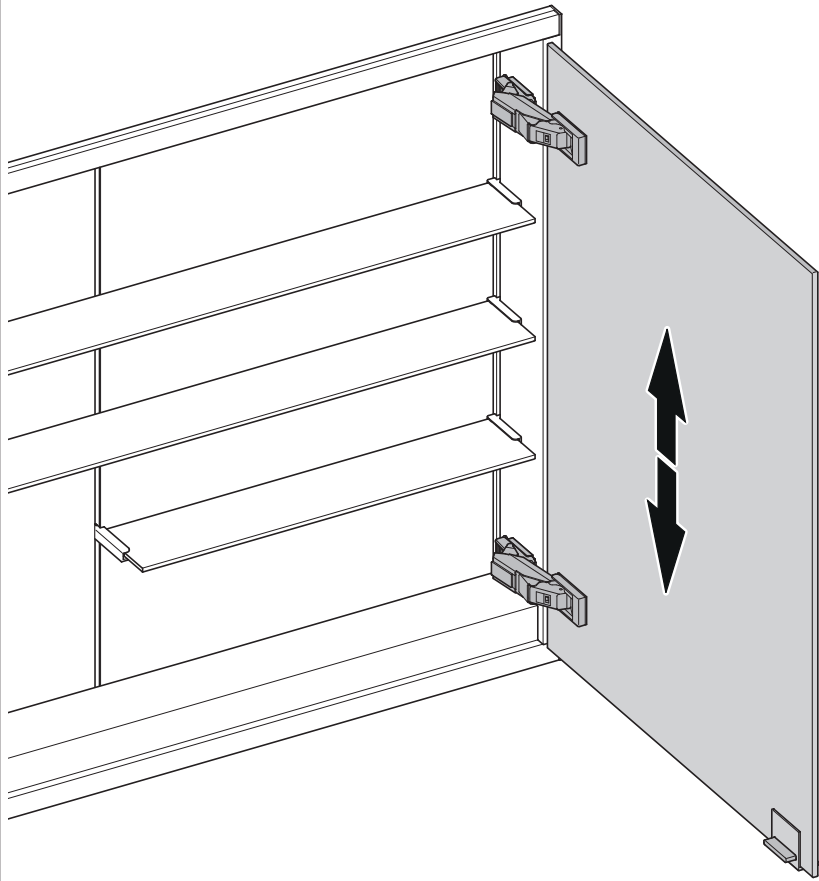

8 

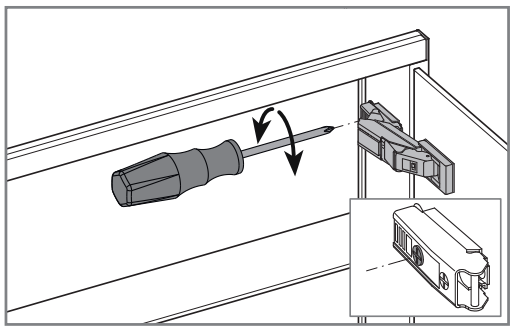
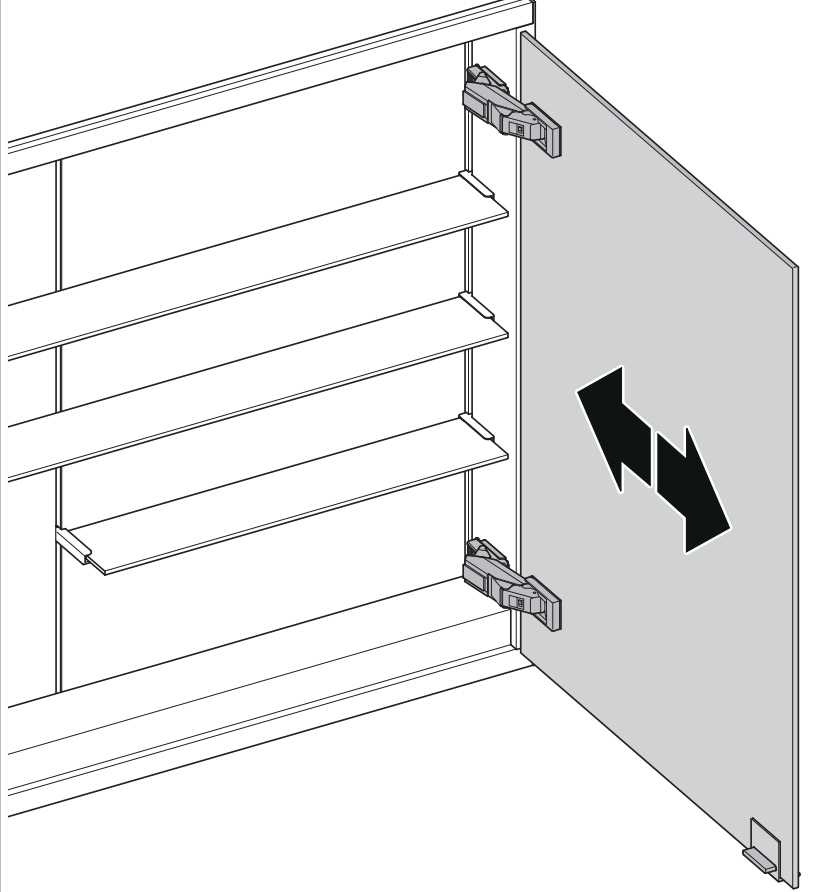

9 **i**

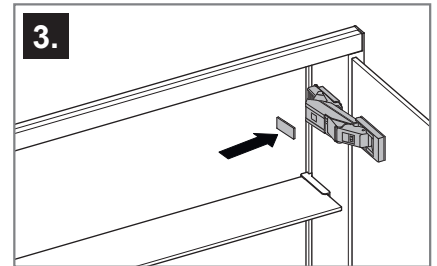
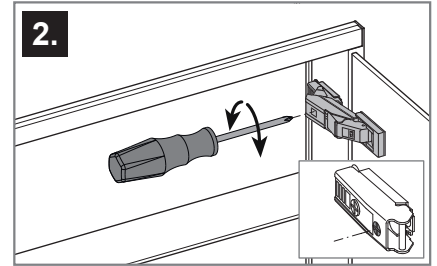
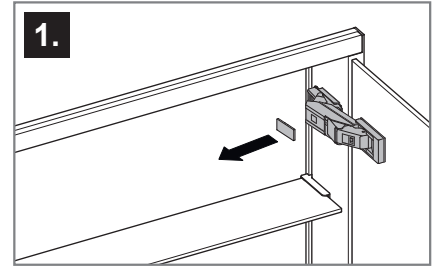
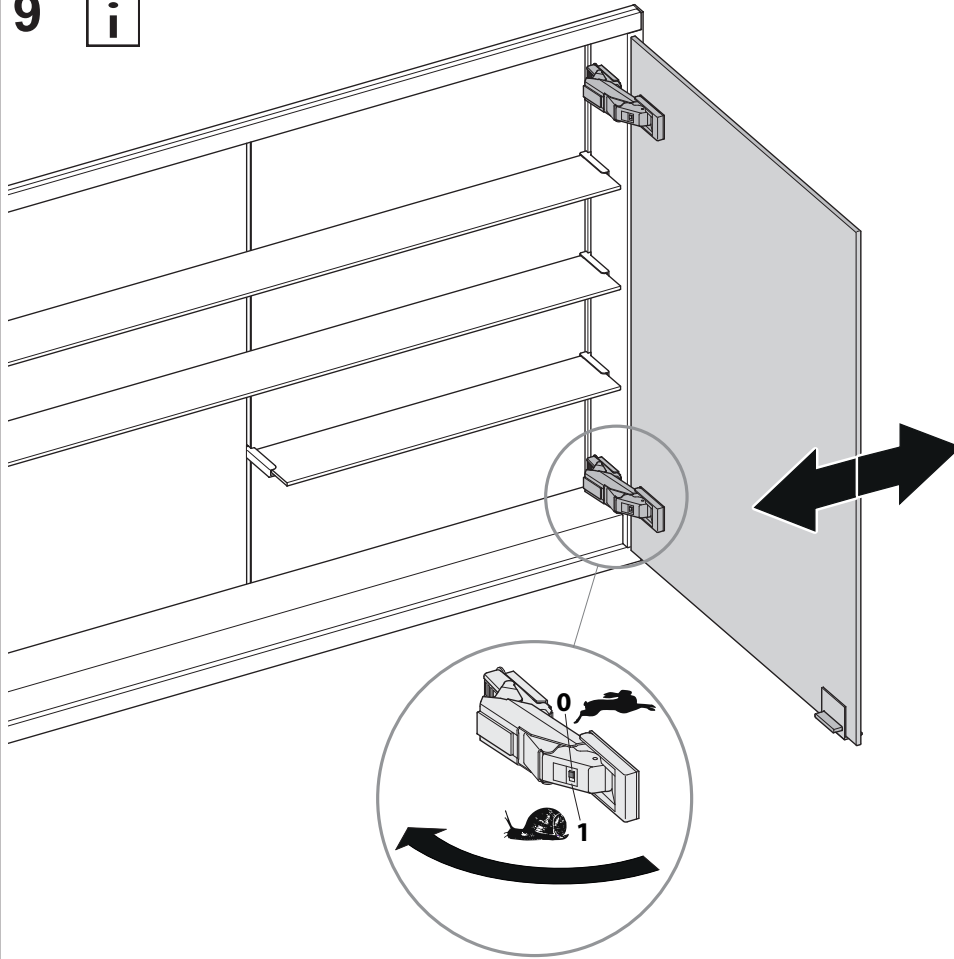



A series of horizontal lines for writing, consisting of 20 parallel lines spaced evenly down the page.



A series of horizontal lines for writing, starting from the top line and extending down to the bottom line.



A series of 20 horizontal lines for writing, spaced evenly down the page.

DE Ersatzteile

FR Pièces de rechange

CS Náhradní díly

EN Spare parts

IT Ricambi

PL Części zamienne

ES Piezas de recambio

NL Reserveonderdelen

RU Запчасти

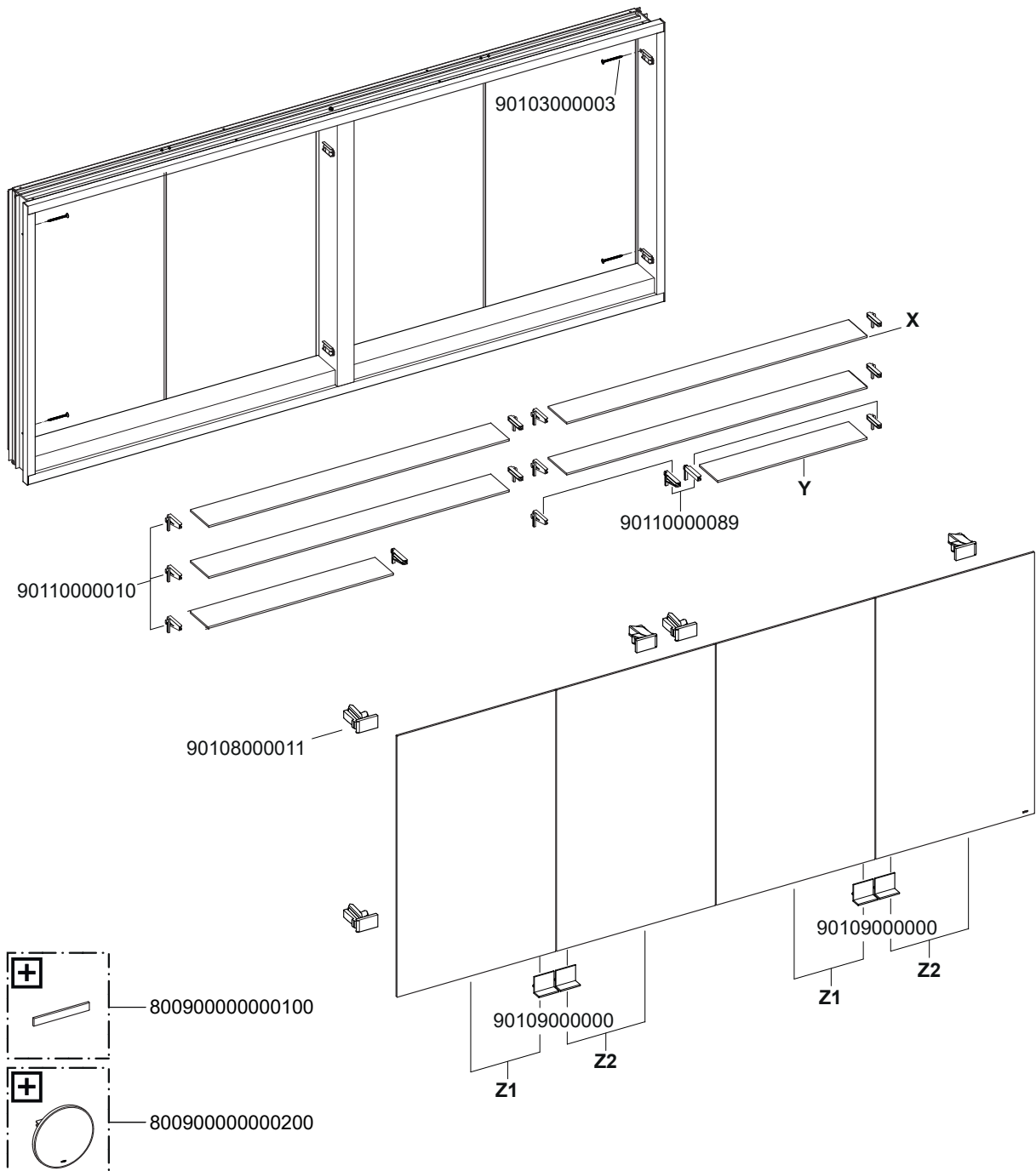

	DD	E	G	X	Y	Z1	Z2
80040016EG0X000	1600	700 / 900	120 / 160	90110000048/ 90110000062	90110000066/ 90110000079	90101010104/ 90101010117	90101010075/ 90101010091
80040017EG0X000	1700			90110000097/ 90110000106	90110000102/ 90110000111	90101010128/ 90101010131	90101010134/ 90101010137
80040001EG0X000	1750			90110000117/ 90110000119	90110000118/ 90110000120	90101010159/ 90101010161	90101010160/ 90101010162
80040018EG0X000	1800			90110000098/ 90110000107	90110000103/ 90110000112	90101010095/ 90101010108	90101010067/ 90101010083
80040019EG0X000	1900			90110000099/ 90110000108	90110000104/ 90110000113	90101010129/ 90101010132	90101010135/ 90101010138
80040020EG0X000	2000			90110000100/ 90110000109	90110000075/ 90110000088	90101010096/ 90101010109	90101010061/ 90101010077
80040021EG0X000	2100			90110000101/ 90110000110	90110000105/ 90110000114	90101010130/ 90101010133	90101010136/ 90101010139

