

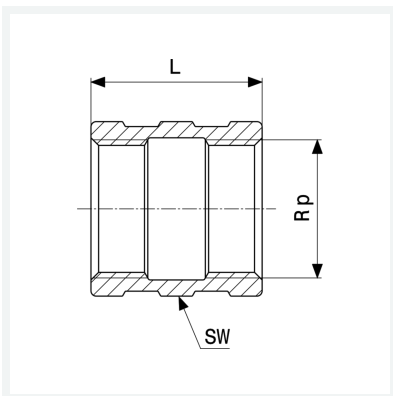

**Muffe**  
- Rp-Gewinde  
**Ausstattung**  
Mehrkant  
**Modell 3270**  
  
**Artikel 441 395**



## Eigenschaften

Innengewinde zylindrisch	Rp	1/8
Länge	L	16 mm
Schlüsselweite	SW	14 mm
Gewicht	11,6 g	
Volumen	24,864 cm <sup>3</sup>	
Werkstoff	Rotguss oder Siliziumbronze	