

DE Montageanleitung

EN Mounting instruction

ES Instrucciones de instalación

FR Instructions d'installation

IT Istruzioni per l'installazione

NL Montagehandleiding

CS Návod k instalaci

PL Instrukcja montażu

RU Инструкция по монтажу

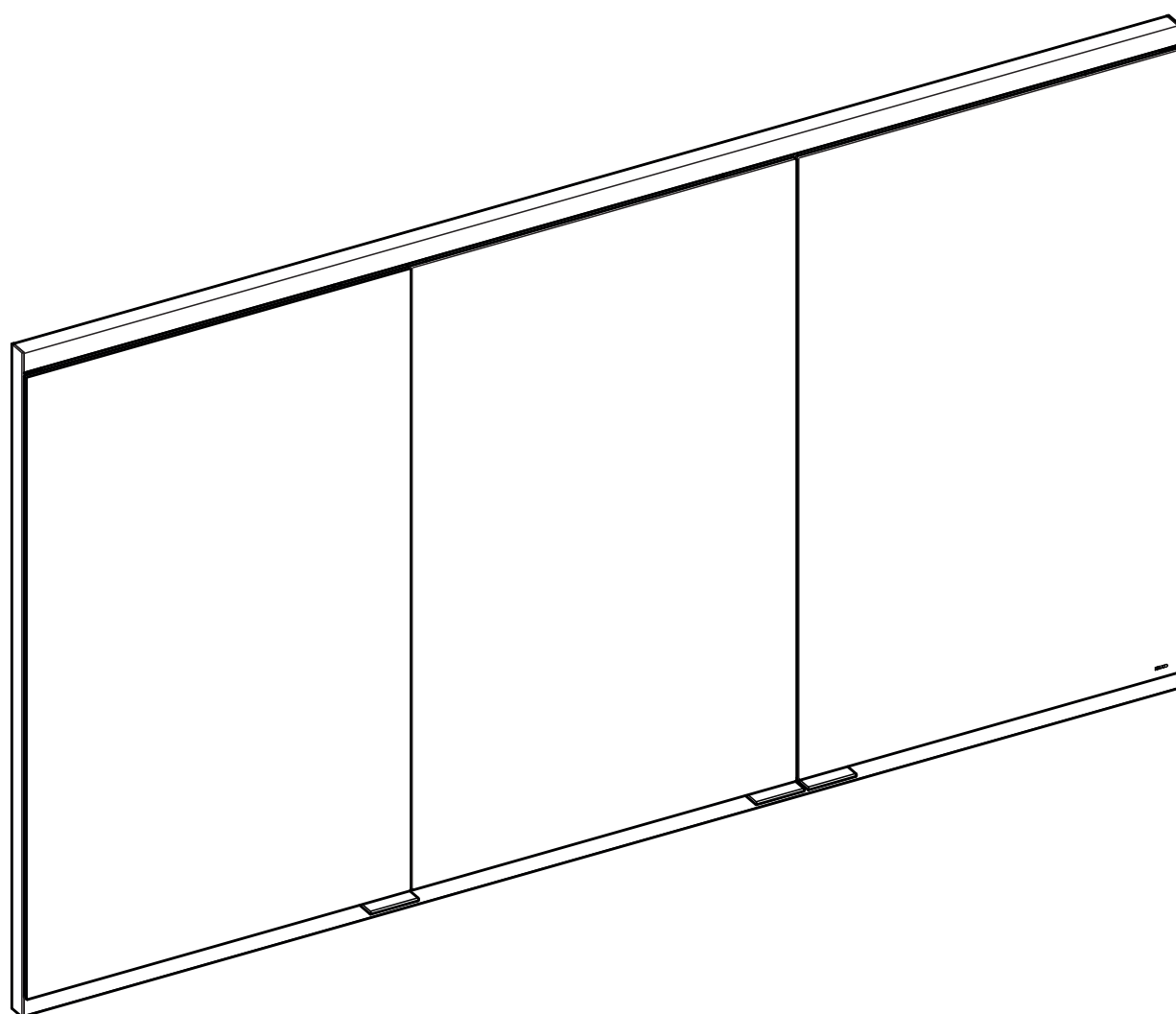

800300DDEG0X000

DE Einbaumaße

FR Cotes de montage

CS Montážní rozměry

EN Mounting dimensions

IT Ingombro

PL Wymiary montażowe

ES Dimensiones de montaje

NL Montageafmetingen

RU Монтажные размеры

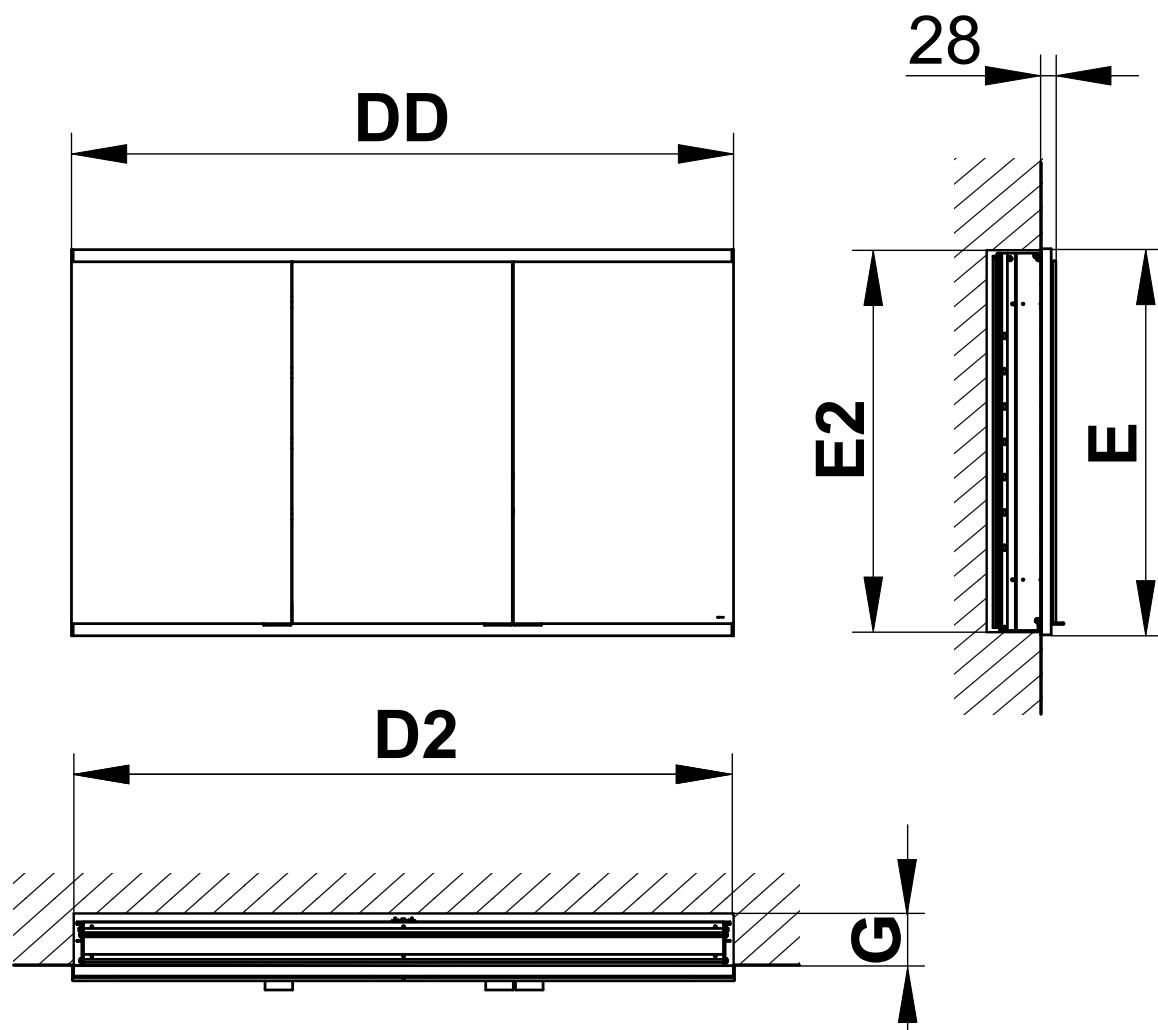









	DD	D2	E	E2	G
800300090G0X000	900	886 - 894	700	686 - 690	>102 / >142
800300100G0X000	1000	986 - 994	700	686 - 690	>102 / >142
800300000G0X000	1050	1036 - 1044	700	686 - 690	>102 / >142
800300110G0X000	1100	1086 - 1094	700	686 - 690	>102 / >142
800300120G0X000	1200	1186 - 1194	700	686 - 690	>102 / >142
800300130G0X000	1300	1286 - 1294	700	686 - 690	>102 / >142
800300140G0X000	1400	1386 - 1394	700	686 - 690	>102 / >142
800300150G0X000	1500	1486 - 1494	700	686 - 690	>102 / >142
800300091G0X000	900	886 - 894	900	886 - 890	>102 / >142
800300101G0X000	1000	986 - 994	900	886 - 890	>102 / >142
800300001G0X000	1050	1036 - 1044	900	886 - 890	>102 / >142
800300111G0X000	1100	1086 - 1094	900	886 - 890	>102 / >142
800300121G0X000	1200	1186 - 1194	900	886 - 890	>102 / >142
800300131G0X000	1300	1286 - 1294	900	886 - 890	>102 / >142
800300141G0X000	1400	1386 - 1394	900	886 - 890	>102 / >142
800300151G0X000	1500	1486 - 1494	900	88 6- 890	>102 / >142



DE Wichtige Informationen, bitte unbedingt lesen!

 Diese Anleitung ist für den Installateur zur Montage sowie für den Nutzer zur Bedienung und Wartung des Produktes. Bitte nach der Installation an den Nutzer zur Verwahrung weitergeben.



Symbole und Bedeutung

-  **Achtung!** Warnung vor Personen- oder Sachschaden.
-  **Achtung!** Warnung vor Stromschlag.
-  **Achtung!** Warnung vor Wasserschaden.
-  Hinweis, Tipp oder Verweis
-  Korrekte Montage/Funktionsprüfung
-  Falsche Montage
-  Montagedetail beachten
-  Optional/Zubehör

Sicherheitsinformationen

-  Es muss sichergestellt sein, dass die Wand das Gewicht des Spiegels tragen kann.
-  Zur Vermeidung von Personen- und Sachschäden muss die Montage von zwei Personen durchgeführt werden.

Verwendungszweck

-  Produkt ausschließlich zur Montage in Innenräumen geeignet!
-  **Achtung!** Installation nur in frostfreien Räumen.

Einbaumaße, siehe Seite 2.

Installation, siehe ab Bild 1 auf Seite 8.









Ersatzteile mit Bestellnummern, siehe Seite 15.

 Hinweise zur Gewährleistung und Pflege sind dem beiliegendem **Pflege- und Garantiepasse** zu entnehmen.



EN Important information, please read!

 These instructions are designed for the installation engineer to assemble the product and for the user to operate and maintain it. After installation, please pass them on to the user for safekeeping.



Symbols and their meaning

-  **Caution!** Warning of personal injury or material damage
-  **Caution!** Warning of electric shock.
-  **Caution!** Warning of water damage.
-  Note, tip or reference
-  Correct assembly/functional test
-  Incorrect assembly
-  Observe assembly details
-  Optional/accessories

Safety Information

-  It must be ensured that the wall can support the weight of the mirror.
-  To prevent personal injury or material damage the assembly must be carried out by two persons.

Intended use

-  The product is suitable only for mounting indoors!
-  **Caution!** Only install in frost-free rooms.

Mounting dimensions, see page 2.









Installation, see figure 1 onwards on page 8.

Replacement parts with order numbers, see page 15.

 For information about warranty and maintenance, see the enclosed **Care Instructions and Warranty Card**.

 Este manual está destinado al instalador para el montaje, así al usuario para el manejo y mantenimiento del producto. Por favor, después de la instalación este manual se debe entregar al usuario para que lo conserve.

Símbolos y significado



-  **¡Atención!** Advertencia de daños personales o materiales.
-  **¡Atención!** Advertencia de descarga eléctrica.
-  **¡Atención!** Advertencia de daños a causa del agua.
-  Indicación, consejo o referencia
-  Montaje correcto/Comprobación de funcionamiento
-  Montaje erróneo
-  Observar el detalle de montaje
-  Opcional/Accesorios

Informaciones de seguridad

 Tiene que estar asegurado, que la pared puede soportar el peso del espejo.

 Para evitar daños personales y materiales el montaje tiene que ser llevado a cabo con dos personas.

Finalidad de uso

-  ¡Producto exclusivamente para el montaje en interiores!
-  **¡Atención!** Instalación exclusivamente en espacios sin hielo.

Medidas de montaje, véase página 2.









Instalación, véase imagen 1 en la página 8.

Piezas de recambio con números de pedido, véase página 15.

 La información sobre la garantía y el cuidado se puede encontrar en el **manual de mantenimiento y de garantía** adjunto.

 Ces instructions sont destinées à l'installateur, pour effectuer le montage, et à l'utilisateur, pour utiliser le produit et procéder à sa maintenance. Après l'installation, veuillez remettre ces instructions à l'utilisateur pour qu'il les conserve.

Symboles et leur signification



-  **Attention !** Mise en garde contre les dégâts de personnes et les dégâts matériels.
-  **Attention !** Mise en garde contre les chocs électriques.
-  **Attention !** Mise en garde contre les endommagements par l'eau.
-  Remarque, conseil ou renvoi
-  Montage correct/contrôle fonctionnel
-  Montage incorrect
-  Respecter le détail de montage
-  Option/accessoires

Informations en matière de sécurité

 Il convient de s'assurer que le mur peut supporter le poids du miroir.

 Pour éviter les les dégâts de personnes et les dégâts matériels, le montage doit être effectué par deux personnes.

Domaine d'utilisation

-  Le produit ne convient que pour un montage à l'intérieur !
-  **Attention !** Installation uniquement dans des pièces à l'abri du gel.

Côtes d'encombrement, voir page 2.

Installation, voir à partir de la figure 1, à la page 8.

Pièces de rechange avec numéros de commande, voir page 15.

 Les consignes relatives à la garantie et à l'entretien figurent sur la **instructions d'entretien et carte de garantie** jointe.

 Il presente manuale è indirizzato agli installatori per il montaggio nonché agli utilizzatori per l'uso e la manutenzione del prodotto. Consegnarlo all'utilizzatore dopo l'installazione affinché lo custodisca.

 Deze handleiding is zowel voor de installatiemonteur, als voor de gebruiker voor de bediening en het onderhoud van het product bedoeld. Geef de handleiding na de installatie aan de gebruiker om te bewaren.

Simboli e significato

 **Attenzione!** Pericolo di lesioni o danni materiali.

 **Attenzione!** Pericolo di folgorazione.

 **Attenzione!** Pericolo di danni causati dall'acqua.

 Avvertenza, consiglio o rimando

 Montaggio corretto/verifica del funzionamento

 Montaggio errato

 Prestare attenzione al dettaglio di montaggio

 Opzionale/accessorio

Informazioni di sicurezza

 Deve essere garantito che la parete possa supportare il peso dello specchio.

 Al fine di evitare lesioni e danni materiali il montaggio deve essere eseguito da due persone.

Scopo d'uso

 Prodotto adatto esclusivamente per il montaggio in ambienti interni!

 **Attenzione!** Installazione solo in ambienti in assenza di gelo.

Dimensioni di montaggio, vedi pagine 2.

Installazione, vedi dalla figura 1 a pagina 8.

Ricambi con numero d'ordine, vedi pagina 15.

 Indicazioni relative alla garanzia e al trattamento vanno desunte dalle **istruzioni di manutenzione e certificato di garanzia**.

Symbolen en betekenis

 **Opgepast!** Waarschuwing voor lichamelijke en materiële schade.

 **Opgepast!** Waarschuwing voor elektrische schokken.

 **Opgepast!** Waarschuwing voor waterschade.

 Aanwijzing, tip of verwijzing

 Controle van correcte montage/werking

 Verkeerde montage

 Montagedetail respecteren

 Optioneel/accessoire

Veiligheidsinformatie

 Er moet worden gecontroleerd of de wand het gewicht van de spiegel kan dragen.

 Om schade aan personen of zaken te vermijden moet de montage door twee personen worden uitgevoerd.

Beoogd gebruik

 Het product is uitsluitend voor montage in binnenruimten geschikt!

 **Opgepast!** Installatie alleen in vorstvrije ruimten.

Inbouwafmetingen, zie pagina 2.









Installatie, zie vanaf afbeelding 1 op pagina 8.

Wisselstukken met bestelnummers, zie pagina 15.



 Instructies voor de waarborg en het onderhoud vindt u in de meegeleverde **aanwijzingen voor het onderhoud en garantiebewijs**.

 Tento návod slouží instalatérům při montáži a uživatelům při obsluze a údržbě produktu. Po nainstalování ho předejte uživateli, aby si ho mohl uschovat.



Symbole a jejich význam

-  **Pozor!** Výstraha před zraněním a materiálními škodami.
-  **Pozor!** Výstraha před úrazem elektrickým proudem.
-  **Pozor!** Výstraha před poškozením vodou.
-  Upozornění, tip nebo odkaz
-  Správná montáž / kontrola funkčnosti
-  Nesprávná montáž
-  Při montáži dbejte na tento detail
-  Volitelná výbava / příslušenství

Informace o bezpečnosti

-  Je nutné zajistit, aby stěna unesla hmotnost zrcadlové skříňě.
-  Aby se zabránilo zraněním a materiálním škodám, musí montáž provádět dvě osoby.

Účel použití

-  Výrobek je vhodný výhradně k montáži ve vnitřních prostorech!
-  **Pozor!** Instalace v prostorech, které nepromrzají.

Montážní rozměry viz straně 2.









Instalace viz obr. 1 na straně 8.

Náhradní díly s objednáacími čísly viz straně 15.



 Pokyny týkající se záruky a péče najdete v příloženém **Návodu k údržbě a záručním listu**.

 Instrukcja przeznaczona jest dla instalatora, zapewniając pomoc w zakresie montażu oraz dla użytkownika, informując go o sposobie obsługi i konserwacji produktu. Po instalacji należy przekazać instrukcję użytkownikowi, aby ją u siebie przechowywał.



Symbole i znaczenie

-  **Uwaga!** Ostrzeżenie przed szkodami osobowymi i materialnymi.
-  **Uwaga!** Ostrzeżenie przed porażeniem prądem elektrycznym.
-  **Uwaga!** Ostrzeżenie przed szkodami, spowodowanymi przez wodę.
-  Informacja, dobra rada lub odsylacz
-  Właściwy montaż/kontrola funkcjonowania
-  Niewłaściwy montaż
-  Należy stosować się do danych, dotyczących montażu
-  Opcje/Osprzęt

Informacje dotyczące bezpieczeństwa

-  Należy upewnić się, że ściana jest w stanie unieść ciężar lustra.
-  W celu uniknięcia szkód osobowych i materialnych montaż powinny wykonywać dwie osoby.

Przeznaczenie

-  Produkt przeznaczony jest wyłącznie do montażu wewnątrz budynków!
-  **Uwaga!** Instalacja wyłącznie w pomieszczeniach, w których temperatura nie spada poniżej zera.

3Wymiary zabudowy, patrz stronie 2.

Instalacja, patrz rys. 1 na stronie 8 i dalsze.

Części zamiennie z numerami zamówienia, patrz stronie 15.

 Informacje dotyczące gwarancji dostępne są w dołączonej **instrukcja konserwacji i karta gwarancyjna**.

1

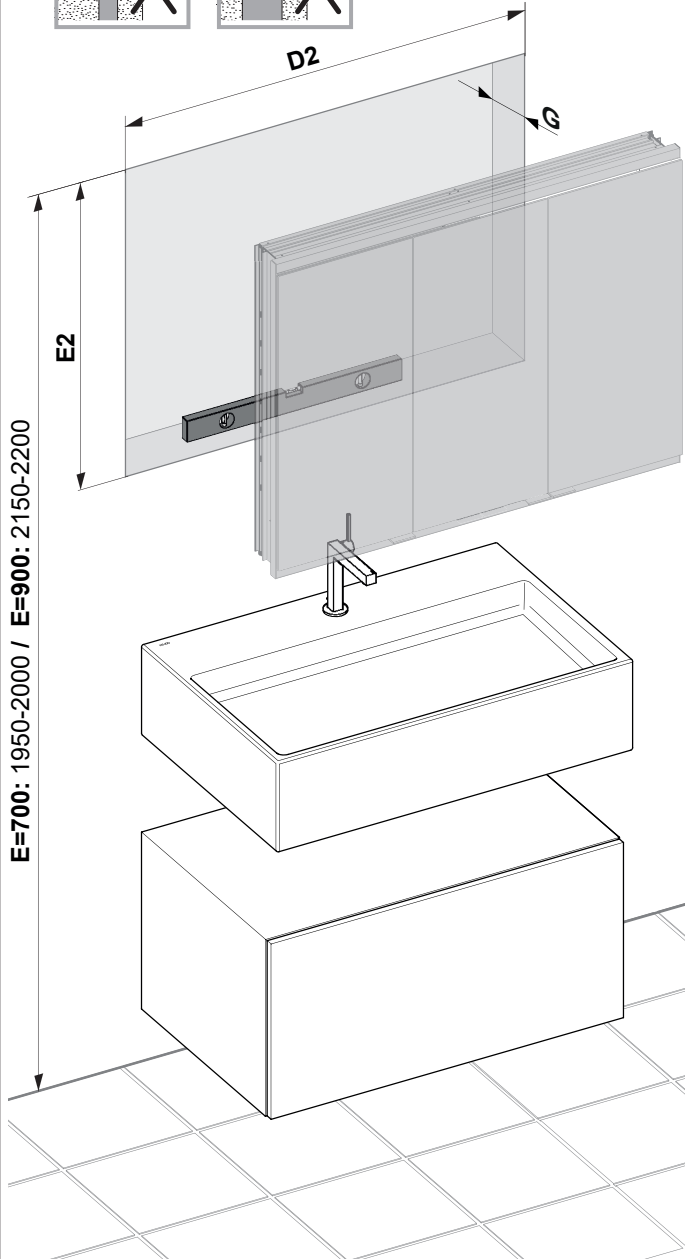
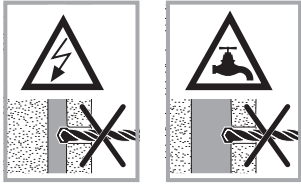

2

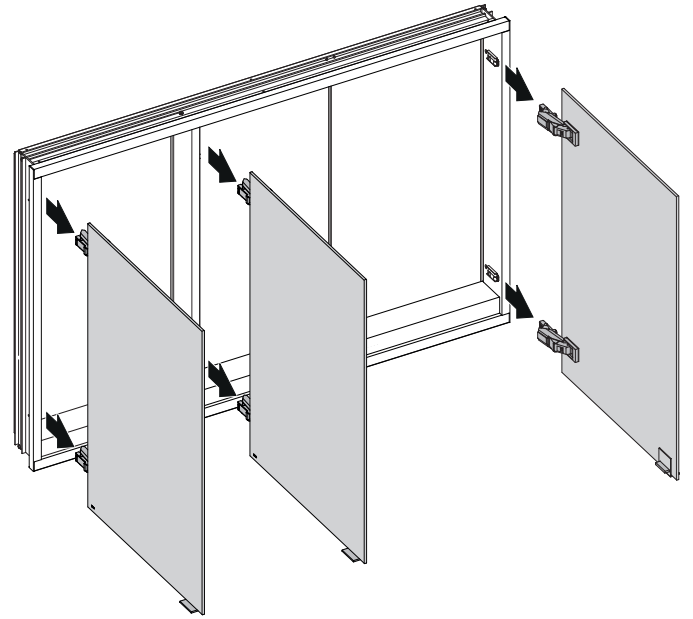

3

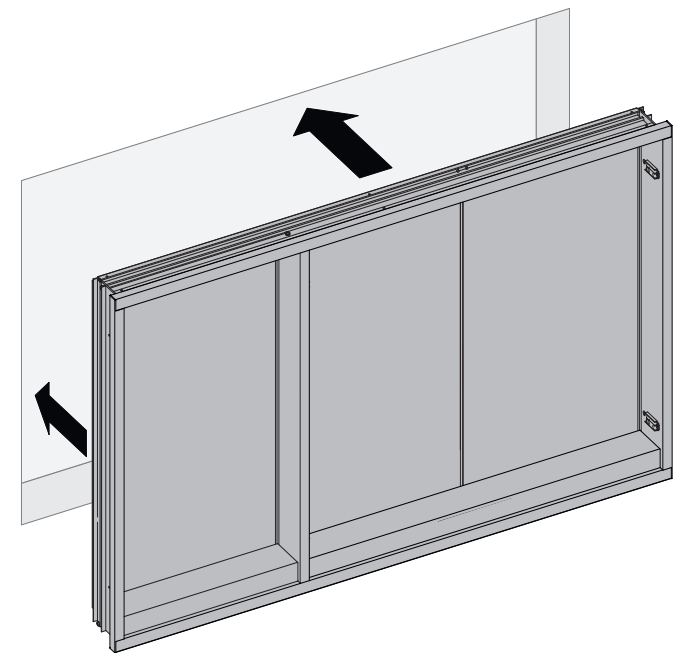

	DD	D2	E	E2	G
800300090G0X000	900	886-894	700	686-690	>102 / >142
800300100G0X000	1000	986-994	700	686-690	>102 / >142
800300000G0X000	1050	1036-1044	700	686-690	>102 / >142
800300110G0X000	1100	1086-1094	700	686-690	>102 / >142
800300120G0X000	1200	1186-1194	700	686-690	>102 / >142
800300130G0X000	1300	1286-1294	700	686-690	>102 / >142
800300140G0X000	1400	1386-1394	700	686-690	>102 / >142
800300150G0X000	1500	1486-1494	700	686-690	>102 / >142
800300091G0X000	900	886-894	900	886-890	>102 / >142
800300101G0X000	1000	986-994	900	886-890	>102 / >142
800300001G0X000	1050	1036-1044	900	886-890	>102 / >142
800300111G0X000	1100	1086-1094	900	886-890	>102 / >142
800300121G0X000	1200	1186-1194	900	886-890	>102 / >142
800300131G0X000	1300	1286-1294	900	886-890	>102 / >142
800300141G0X000	1400	1386-1394	900	886-890	>102 / >142
800300151G0X000	1500	1486-1494	900	886-890	>102 / >142

4

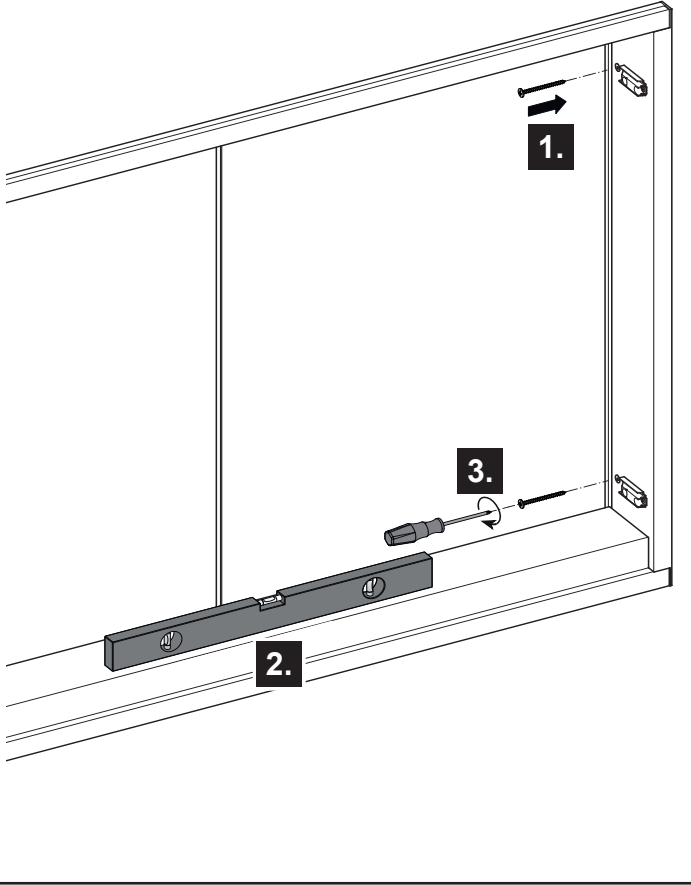

5

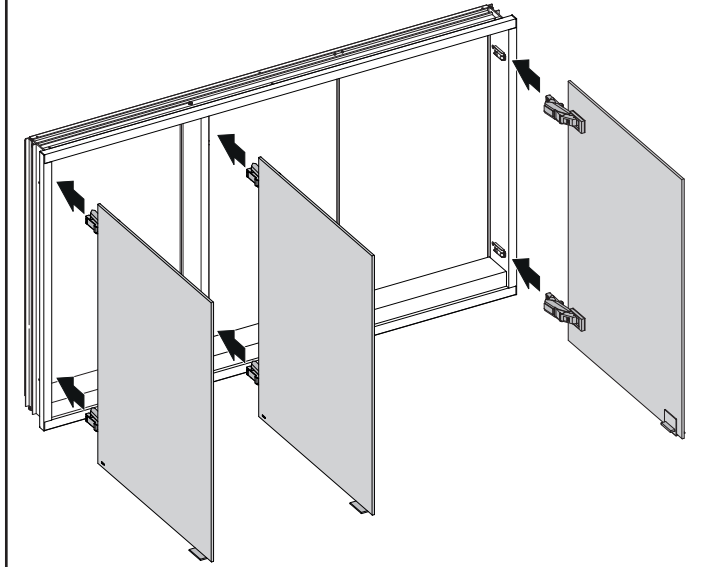

6

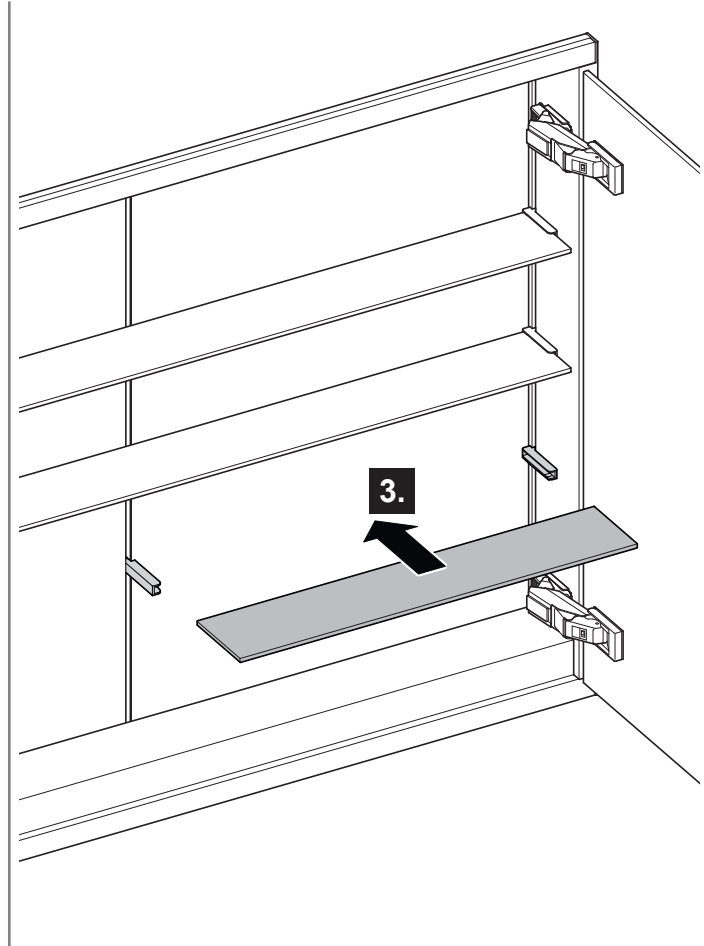
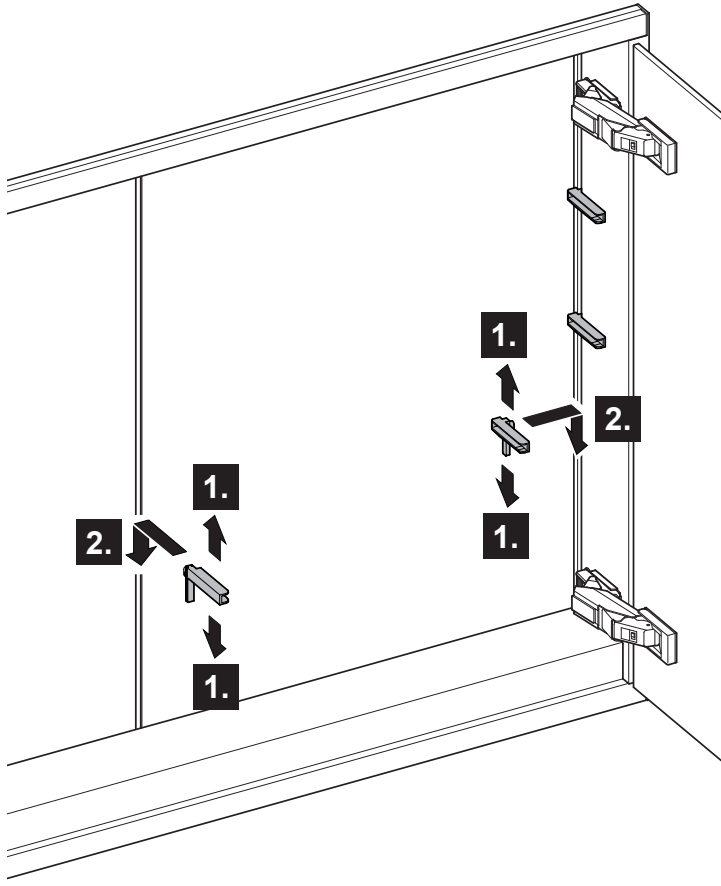

7 

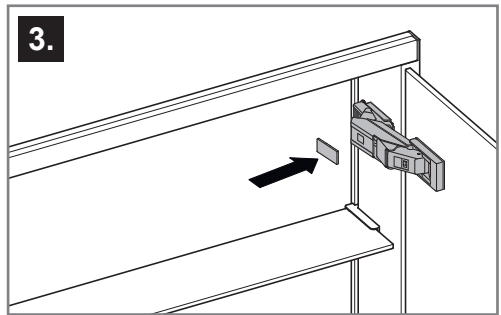
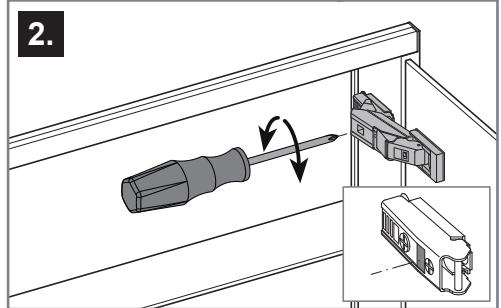
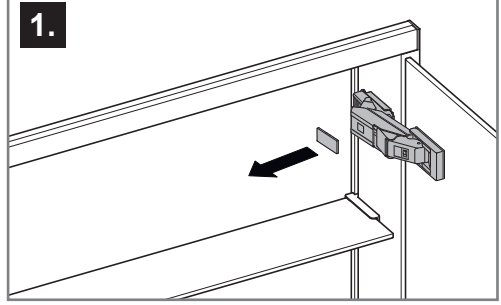
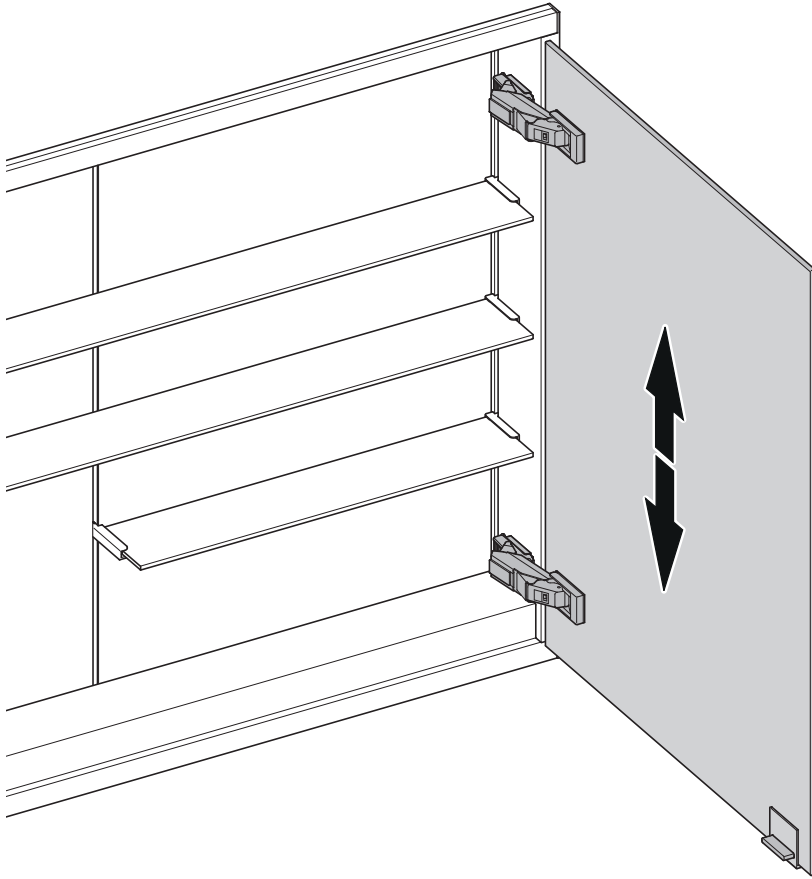

8 

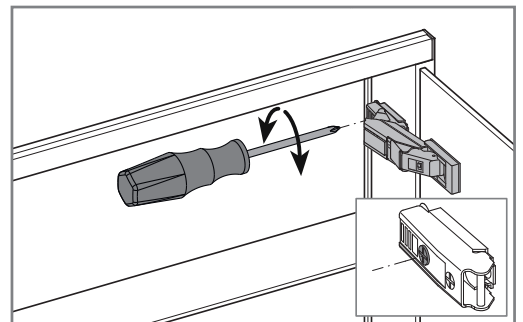
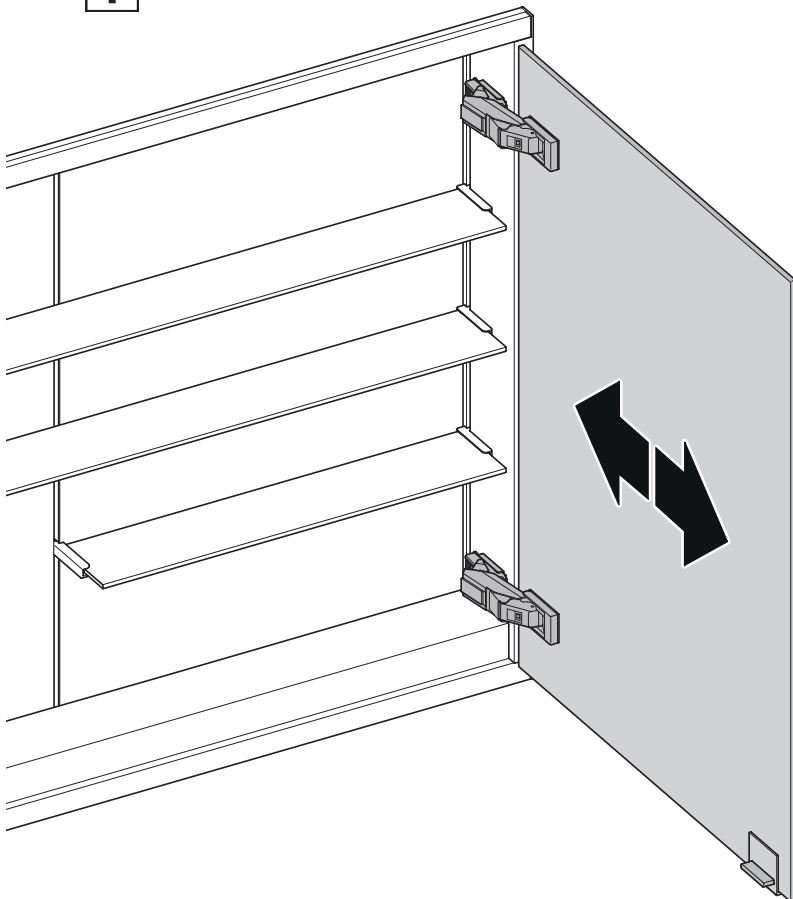

9 **i**

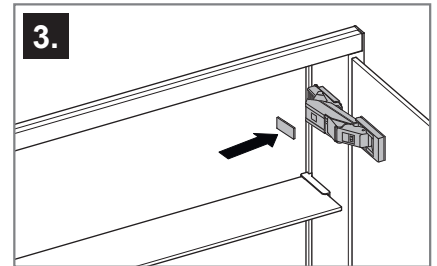
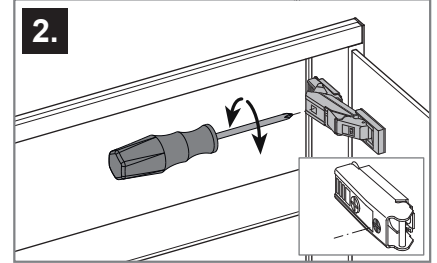
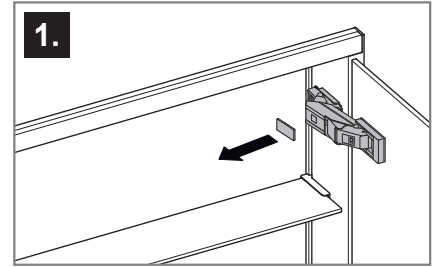
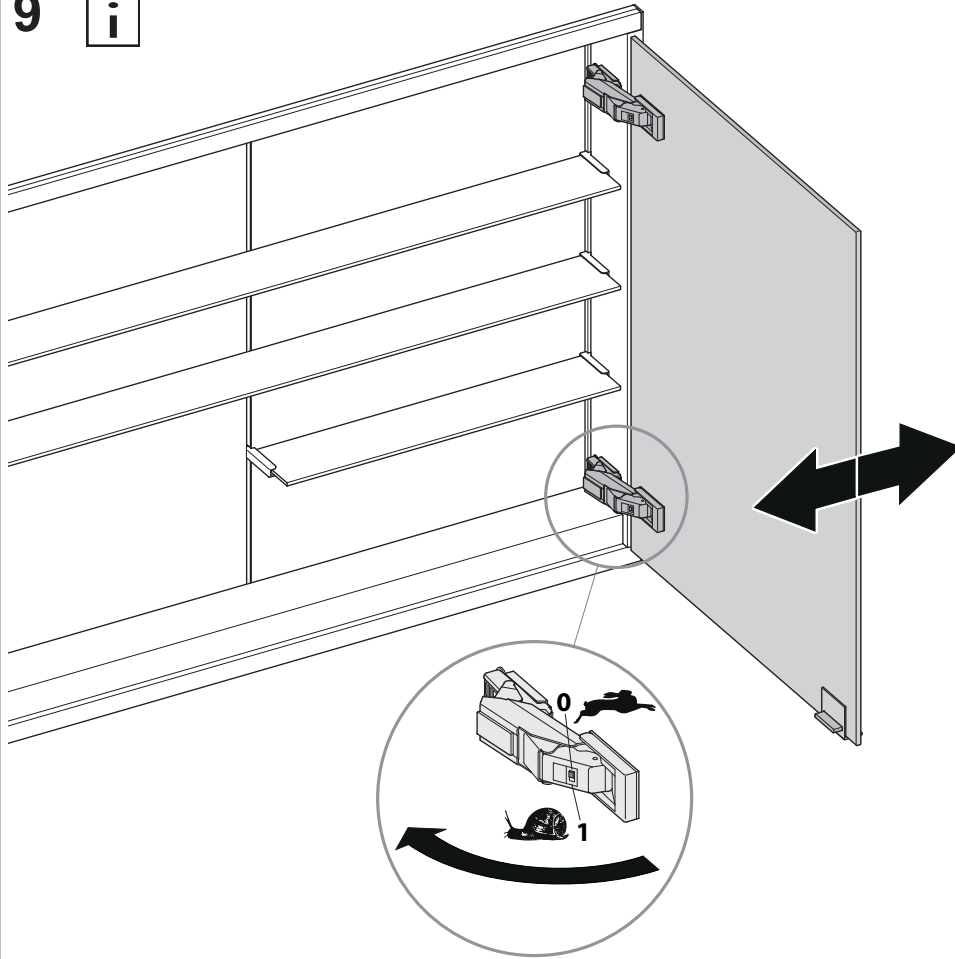



A series of 20 horizontal lines for writing, spaced evenly down the page.



A series of 25 horizontal lines for writing, spaced evenly down the page.



A series of horizontal lines for writing, consisting of 20 evenly spaced lines that span the width of the page.

DE Ersatzteile

FR Pièces de rechange

CS Náhradní díly

EN Spare parts

IT Ricambi

PL Części zamienne

ES Piezas de recambio

NL Reserveonderdelen

RU Запчасти

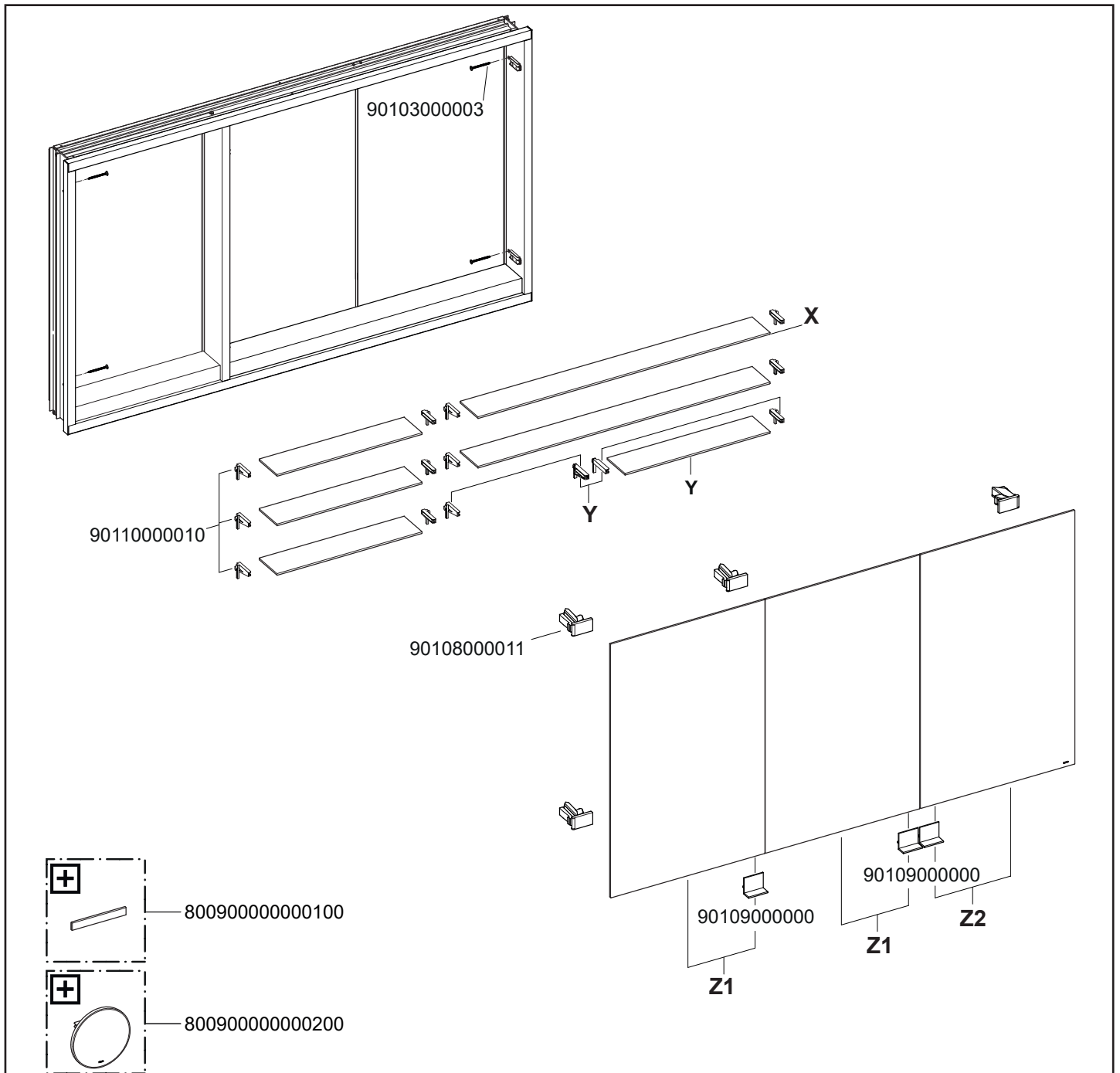

	DD	E	G	X	Y	Z1	Z2
80030009EG0X000	900	700 / 900	120 / 160	90110000043/ 90110000057	90110000064/ 90110000077	90101010099/ 90101010112	90101000070/ 90101010086
80030010EG0X000	1000	700 / 900	120 / 160	90110000044/ 90110000058	90110000071/ 90110000084	90101010100/ 90101010113	90101000071/ 90101010087
80030000EG0X000	1050	700 / 900	120 / 160	90110000037/ 90110000051	90110000065/ 90110000078	90101010093/ 90101010106	90101000065/ 90101010081
80030011EG0X000	1100	700 / 900	120 / 160	90110000045/ 90110000059	90110000072/ 90110000085	90101010101/ 90101010114	90101000072/ 90101010088
80030012EG0X000	1200	700 / 900	120 / 160	90110000038/ 90110000052	90110000066/ 90110000079	90101010094/ 90101010107	90101000066/ 90101010082
80030013EG0X000	1300	700 / 900	120 / 160	90110000046/ 90110000060	90110000073/ 90110000086	90101010102/ 90101010115	90101000073/ 90101010089
80030014EG0X000	1400	700 / 900	120 / 160	90110000047/ 90110000061	90110000074/ 90110000087	90101010103/ 90101010116	90101000074/ 90101010090
80030015EG0X000	1500	700 / 900	120 / 160	90110000040/ 90110000054	90110000075/ 90110000088	90101010096/ 90101010109	90101000061/ 90101010077

