

Edition 400

31572110100 Waschtischunterbau

PRODUKT



ZEICHNUNG

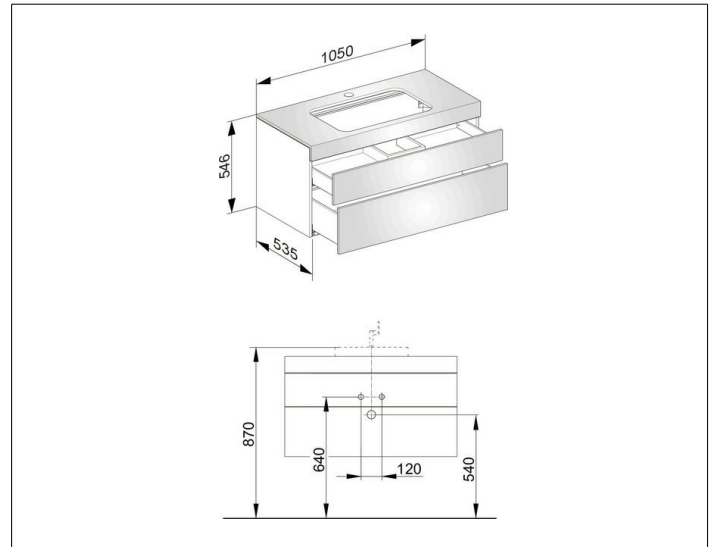

OBERFLÄCHE

anthrazit/Glas anthrazit klar

ABMESSUNG

1050 x 546 x 535 mm