



**Profipress G-Kappe
mit SC-Contur**

- Pressanschluss

Ausstattung

Dichtelement HNBR

Modell 2656

Artikel 352 820

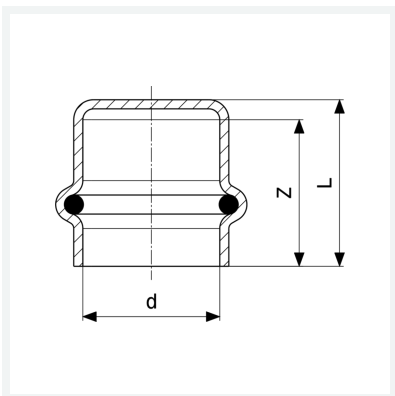

Eigenschaften

Rohraußendurchmesser	d	28
Z-Maß	Z	26 mm
Länge	L	29 mm
Gewicht	54,3 g	
Volumen	124,32 cm ³	
Werkstoff	Kupfer	