

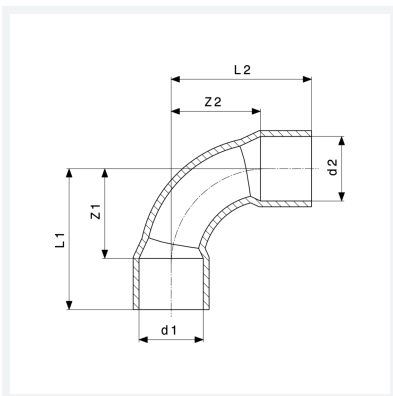

**Winkel 90°**  
 - Lötanschluss  
**Hinweis**  
 WRAS zertifiziertes Produkt  
**Modell 95090**

**Artikel 106 416**



## Eigenschaften

NF-Kennzeichen	NF	✓
Rohraußendurchmesser 1	d1	42
Rohraußendurchmesser 2	d2	42
Z-Maß 1	Z1	34 mm
Z-Maß 2	Z2	34 mm
Länge 1	L1	61 mm
Länge 2	L2	61 mm
Gewicht	204,4 g	
Volumen	497,28 cm <sup>3</sup>	
Werkstoff	Kupfer	