

Datenblatt

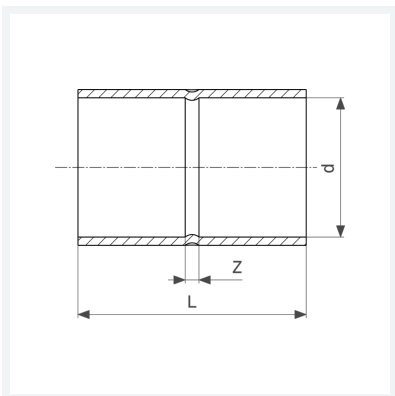

Muffe
- Lötanschluss
Modell 95270

Artikel 100 698



Eigenschaften

Gütesicherung Cu	Cu	✓
Rohraußendurchmesser	d	28
Z-Maß	Z	2 mm
Länge	L	38 mm
Gewicht	33,7 g	
Volumen	124,32 cm ³	
Werkstoff	Kupfer	