

Royal Modular 2.0
800020051100100 Spiegelschrank

PRODUKT

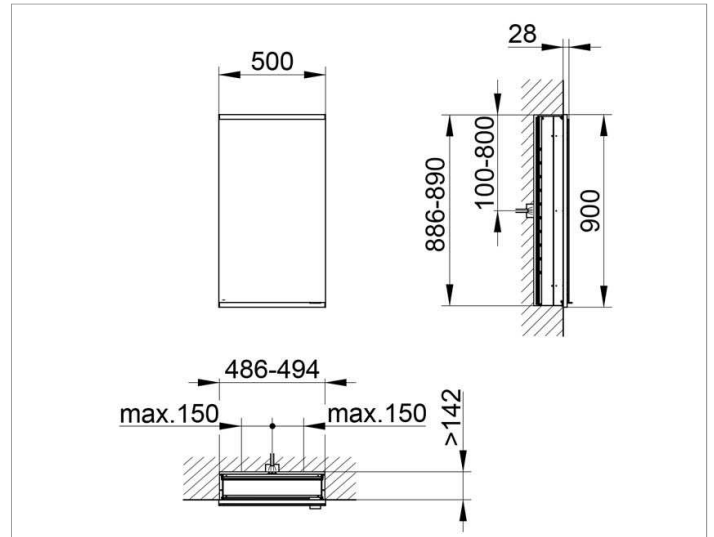

ZEICHNUNG



EEK: A++, A+, A ,

OBERFLÄCHE

silber-eloxiert

ABMESSUNG

500 x 900 x 160 mm